

BELP(MP,HP)-D Ultima Series

50Hz Ducted Fan Coil VRF Indoor Unit
Technical Manual

220~240V/1/50Hz

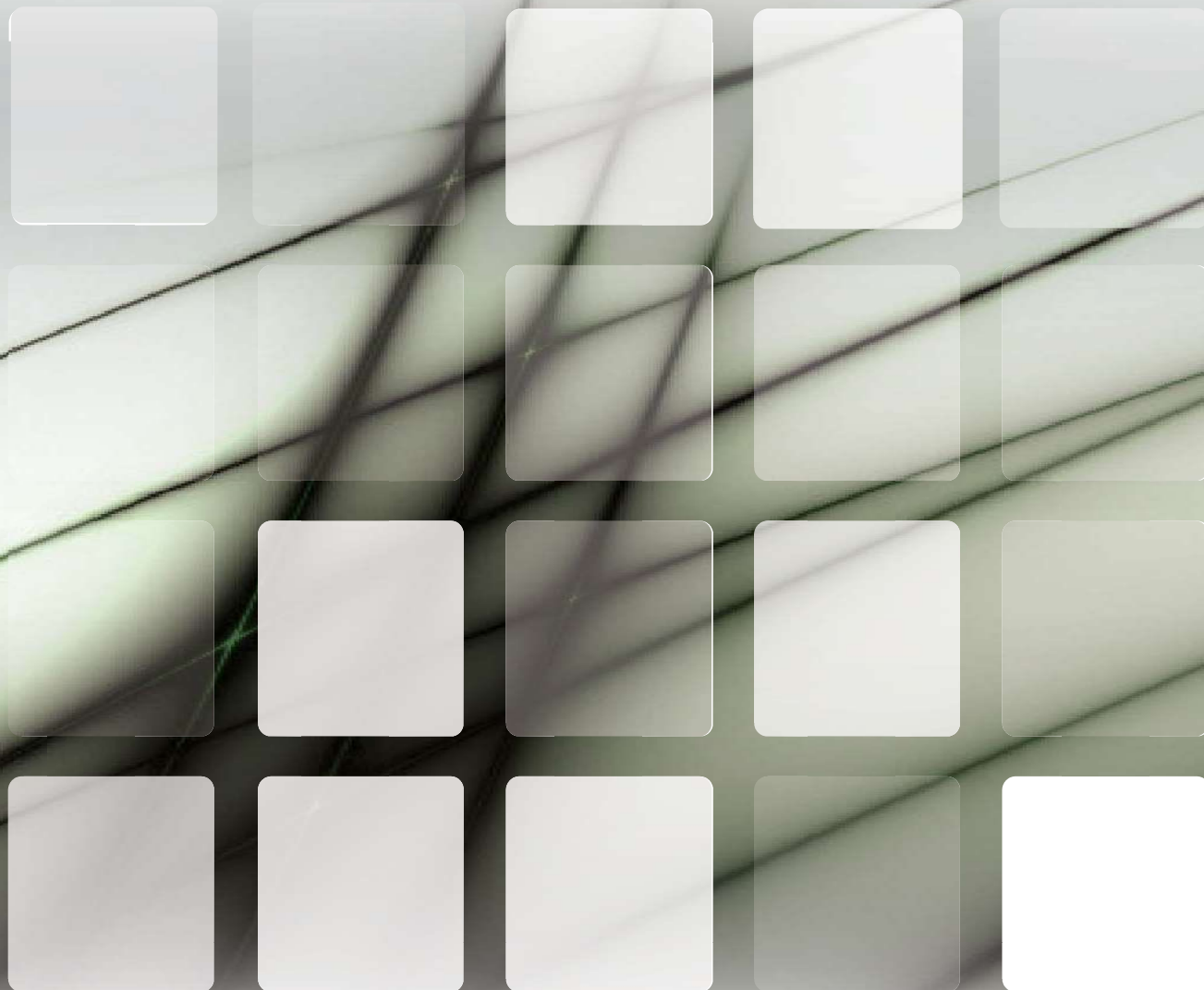

R410A

Commercial Air Conditioners

Technical Manual

Low/Medium/High Static Pressure
Ducted Unit 50 Hz

VRF IDU



BELP008Q3A-DCM022

BELP010Q3A-DCM028

BELP012Q3A-DCM036

BELP015Q3A-DCM045

BELP019Q3A-DCM056

BEMP024Q3A-DCM071

BEMP027Q3A-DCM080

BEMP031Q3A-DCM090

BEMP038Q3A-DCM112

BEMP048Q3A-DCM140

BEHP060Q3A-DCM160

Medium Static Pressure Duct

1 Specifications	4
2 Dimensions	8
3 Unit Placement	10
4 Piping Diagram	11
5 Wiring Diagram	12
6 Fan Performance	14
7 Capacity Tables.....	16
8 Electrical Characteristics.....	17
9 Sound Levels	18

Ultima Series VRF Indoor Units

1 Specifications

BELP008Q3A-DCM022 / BELP010Q3A-DCM028 / BELP012Q3A-DCM036

Table 1.1: BELP008(10, 12) specifications

Model			BELP008Q3A-DCM022	BELP010Q3A-DCM028	BELP012Q3A-DCM036
Power supply			1 phase, 220-240V, 50Hz		
Cooling ¹	Capacity	kBtu/h	7	9	12
	Power input	W	57	57	61
Heating ²	Capacity	kBtu/h	8	10	13
	Power input	W	57	57	61
Fan motor	Type		AC		
	Number		1		
Indoor coil	Number of rows		2	2	2
	Tube pitch × row pitch	mm	21×13.37		
	Fin spacing	mm	1.5	1.5	1.5
	Fin type		Hydrophilic aluminum		
	Tube OD and type	mm	Φ7 Inner-groove		
	Dimensions (L×H ×W)	mm	515×147×26.74	515×147×26.74	515×147×26.74
Number of circuits			3	3	3
Air flow rate(H/M/L)		m ³ /h	550/397/309	550/397/309	605/442/351
Sound pressure level(H/M/L)		dB(A)	31/24/21	31/24/21	35/28/24
Indoor external static pressure		Pa	10(0~30)	10(0~30)	10(0~30)
Indoor unit	Net dimensions (W×H×D)	mm	778x210x500		
	Packed dimensions(W×H×D)	mm	870×285×525		
	Net/Gross weight	kg	18.5/22.2	18.5/22.2	18.5/22.2
Refrigerant type			R410A		
Pipe connections	Liquid/Gas pipe	mm	Φ6.35/ Φ12.7		
	Drain pipe	mm	OD Φ25		

Notes:

1. Indoor temperature 27°C DB, 19°C WB; outdoor temperature 35°C DB; equivalent refrigerant piping length 7.5m with zero level difference.
2. Indoor temperature 20°C DB; outdoor temperature 7°C DB, 6°C WB; equivalent refrigerant piping length 7.5m with zero level difference.

Ultima Series VRF Indoor Units

BELP015Q3A-DCM045 / BELP019Q3A-DCM056 / BEMP024Q3A-DCM071

Table 1.2: BELP015(19,24) specifications

Model			BELP015Q3A-DCM045	BELP019Q3A-DCM056	BEMP024Q3A-DCM071
Power supply			1 phase, 220-240V, 50Hz		
Cooling ¹	Capacity	kBtu/h	15	19	24
	Power input	W	98	103	140
Heating ²	Capacity	kBtu/h	17	21	27
	Power input	W	98	103	140
Fan motor	Type		AC		
	Number		1		
Indoor coil	Number of rows		2		
	Tube pitch × row pitch	mm	21×13.37		
	Fin spacing	mm	1.3		
	Fin type		Hydrophilic aluminum		
	Tube OD and type	mm	Φ7 Inner-groove		
	Dimensions (L×H×W)	mm	734×147×26.74	734×147×26.74	953×147×26.74
	Number of circuits		6		
Air flow rate(H/M/L)		m ³ /h	800/573/479	800/573/479	985/738/630
Sound pressure level(H/M/L)		dB(A)	36/29/26	36/29/27	36/30/27
Indoor external static pressure		Pa	10(0~30)	10(0~30)	10(0~30)
Indoor unit	Net dimensions (W×H×D)	mm	997x210x500	997x210x500	1218x210x500
	Packed dimensions (W×H×D)	mm	1115x285x525	1115x285x525	1335x285x525
	Net/Gross weight	kg	22.5/26.8	22.5/26.8	28/33
Refrigerant type			R410A		
Pipe connections	Liquid/Gas pipe	mm	Φ6.35/ Φ12.7	Φ9.53/ Φ15.9	Φ9.53/Φ15.9
	Drain pipe	mm	OD Φ25		

Notes:

- Indoor temperature 27°C DB, 19°C WB; outdoor temperature 35°C DB; equivalent refrigerant piping length 7.5m with zero level difference.
- Indoor temperature 20°C DB; outdoor temperature 7°C DB, 6°C WB; equivalent refrigerant piping length 7.5m with zero level difference.

Ultima Series VRF Indoor Units

BEMP027Q3A-DCM080) / BEMP031Q3A-DCM090 / BEMP038Q3A-DCM112

Table 1.3: BEMP027(31,38) specifications

Model			BEMP027Q3A-DCM080	BEMP031Q3A-DCM090)	BEMP038Q3A-DCM112
Power supply			1 phase, 220-240V, 50Hz		
Cooling ¹	Capacity	kBtu/h	27	30	38
	Power input	W	198	200	313
Heating ²	Capacity	kBtu/h	30	34	42
	Power input	W	198	200	313
Fan motor	Type		AC		
	Number		1		
Indoor coil	Number of rows		4	4	4
	Tube pitch × row pitch	mm	21×13.5	21×13.5	21×13.5
	Fin spacing	mm	1.5	1.5	1.5
	Fin type		Hydrophilic aluminum		
	Tube OD and type	mm	Φ7 Inner-groove		
	Dimensions (L×H×W)	mm	955×336×53.5	955×336×53.5	955×336×53.5
	Number of circuits		5	8	8
Air flow rate(H/M/L)	m ³ /h	1345/1165/1013	1345/1165/1013	1800/1556/1400	
Sound pressure level(H/M/L)	dB(A)	45/40/37	45/40/37	48/42/38	
*Indoor external static pressure	Pa	20(10~50)	20(10~50)	40(10~80)	
Indoor unit	Net dimensions (W×H×D)	mm	1230×270×775	1230×270×775	1230×270×775
	Packed dimensions (W×H×D)	mm	1355×350×795	1355×350×795	1355×350×795
	Net/Gross weight	kg	35.5/41.5	36/42	36/42
Refrigerant type			R410A		
Pipe connections	Liquid/Gas pipe	mm	Φ9.53/Φ15.9		
	Drain pipe	mm	OD Φ25		

Notes:

- Indoor temperature 27°C DB, 19°C WB; outdoor temperature 35°C DB; equivalent refrigerant piping length 7.5m with zero level difference.
- Indoor temperature 20°C DB; outdoor temperature 7°C DB, 6°C WB; equivalent refrigerant piping length 7.5m with zero level difference.

*This is the available static pressure range which means the unit can run stably in this static pressure range, and the optimal static pressure range please refers to the Installation Manual. When choosing any static pressure which is out of optimal static pressure range, risk like bigger noise, lower air flow volume etc. should be considered in advanced.

Ultima Series VRF Indoor Units

BEMP048Q3A-DCM140 / BEHP060Q3A-DCM160

Table 1.4: BEMP048Q3A-DCM140) specifications

Model			BEMP048Q3A-DCM140	BEHP060Q3A-DCM160
Power supply			1 phase, 220-240V, 50Hz	
Cooling ¹	Capacity	kBtu/h	47	54
	Power input	W	274	940
Heating ²	Capacity	kBtu/h	52	58
	Power input	W	274	940
Fan motor	Type		AC	
	Number		1	
Indoor coil	Number of rows		4	4
	Tube pitch × row pitch	mm	21×13.5	25.4×22
	Fin spacing	mm	1.5	1.6
	Fin type		Hydrophilic aluminum	
	Tube OD and type	mm	Φ7 Inner-groove	
	Dimensions (L×H×W)	mm	1030×378×53.5	996×355.6×88
	Number of circuits		8	7
Air flow rate(H/M/L)		m ³ /h	1905/1636/1400	2875/2587/2383
Sound pressure level(H/M/L)		dB(A)	48/43/39	52/50/48
*Indoor external static pressure		Pa	40(10~100)	50(50~ 196)
Indoor unit	Net dimensions (W×H×D)	mm	1290×300×865	1322×423×691
	Packed dimensions (W×H×D)	mm	1400×375×925	1436×450×768
	Net/Gross weight	kg	46.5/55.5	67/73
Refrigerant type			R410A	
Pipe connections	Liquid/Gas pipe	mm	Φ9.53/Φ15.9	
	Drain pipe	mm	OD Φ25	

Notes:

- Indoor temperature 27°C DB, 19°C WB; outdoor temperature 35°C DB; equivalent refrigerant piping length 7.5m with zero level difference.
- Indoor temperature 20°C DB; outdoor temperature 7°C DB, 6°C WB; equivalent refrigerant piping length 7.5m with zero level difference.

*This is the available static pressure range which means the unit can run stably in this static pressure range, and the optimal static pressure range please refers to the Installation Manual. When choosing any static pressure which is out of optimal static pressure range, risk like bigger noise, lower air flow volume etc. should be considered in advanced.

Ultima Series VRF Indoor Units

2 Dimensions

2.1 Unit Dimensions

Figure 2.1: 7.0-48.0kBtu/h Medium Static Pressure Duct dimensions (unit: mm)

External dimensions and size of air outlet opening:

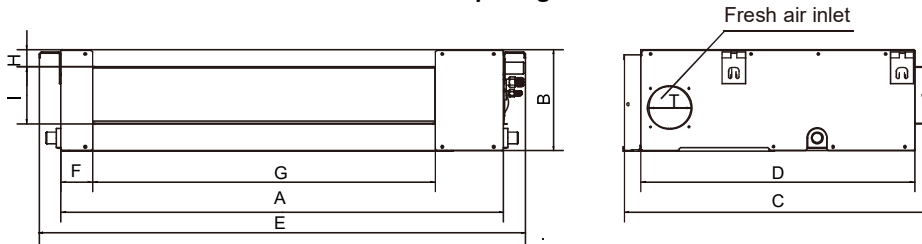

Size of air inlet opening (air intake from rear):

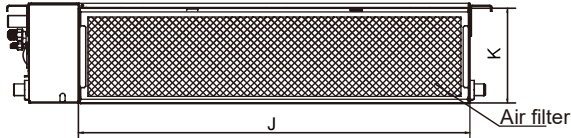

Size of air inlet opening (air intake from below):

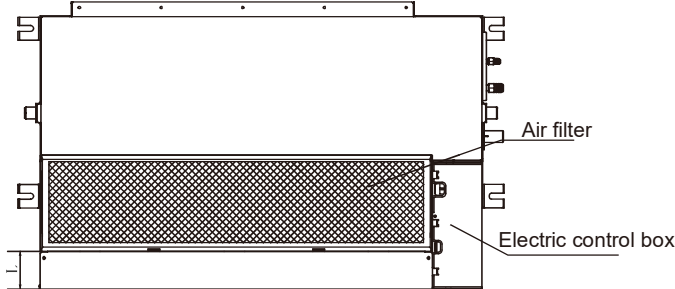

Distance between the lugs:

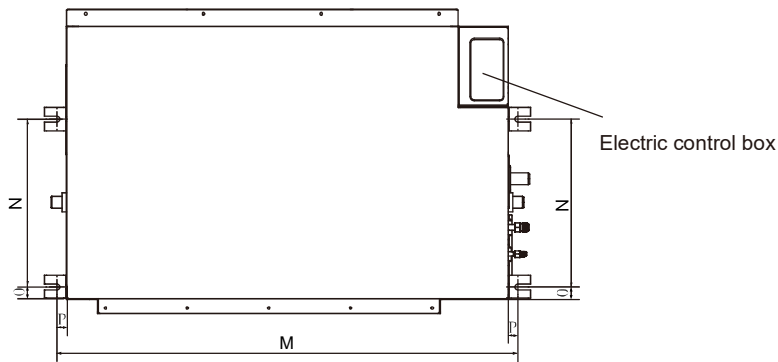

Table 2.1: 7.0-48.0kBtu/h Medium Static Pressure Duct External dimensions and size of air outlet opening (unit: mm)

Model names	External dimensions (mm)					Size of air outlet opening (mm)			
	A	B	C	D	E	F	G	H	I
BELP008(10,12)	700	210	450	500	780	45	145	17	600
BELP015(19)	920	210	450	500	1000	45	145	17	820
BEMPO24Q3A-DCM071	1140	210	450	500	1220	45	145	17	1040
BEMPO27(31,38)	1140	270	775	710	1230	65	933	35	179
BEMPO48Q3A-DCM140	1200	300	865	800	1290	80	968	40	204

Ultima Series VRF Indoor Units

Table 2.2: 7.0-48.0kbtu/h Medium Static Pressure Duct Size of air inlet opening and spacing between lugs (unit: mm)

Model names	Size of air inlet opening (mm)			Spacing between lugs (mm)				Fresh air inlet diameter
	J	K	L	M	N	O	P	
BELP008(10,12)	600	196	-	740	350	35	20	Φ92
BELP015(19)	820	200	-	960	350	35	20	Φ92
BEMP024Q3A-DCM071	1040	200	-	1180	350	35	20	Φ92
BEMP027(31,38)	1035	260	20	1180	490	26	20	Φ125
BEMP048Q3A-DCM140	1094	288	45	1240	500	26	20	Φ125

Figure 2.2: 56.0kbtu/h Medium Static Pressure Duct dimensions (unit: mm)

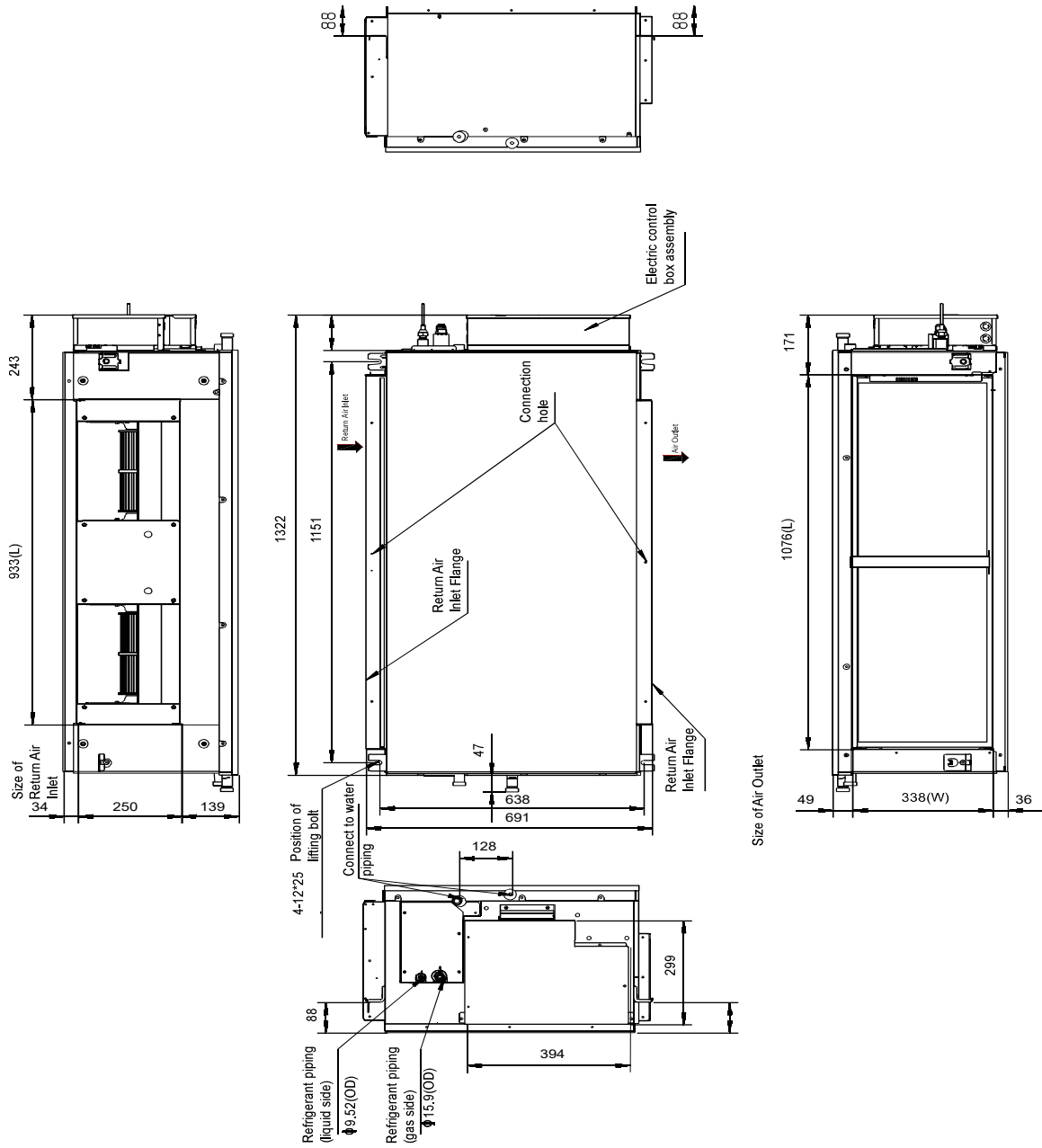

Units 3 Unit Placement

3.1 Placement Considerations

- Unit placement should take account of the following considerations:
 - Ensure the needed spaces for installation and maintenance.
 - The ceiling is horizontal, and its structure can endure the weight of the indoor unit.
 - The outlet and the inlet are not impeded.
 - The air flow can reach throughout the room.
 - The connecting pipe and drainpipe could be extracted out easily.
 - There is no direct radiation from heaters.

3.2 Space Requirements

- Below is the recommended duct installation method:

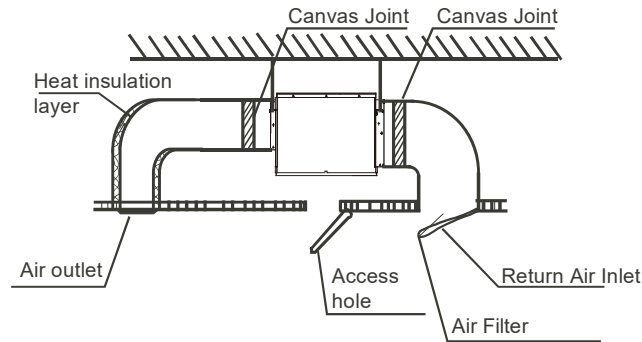

- Keep min. 600(mm)*600(mm) space for checking & maintenance:

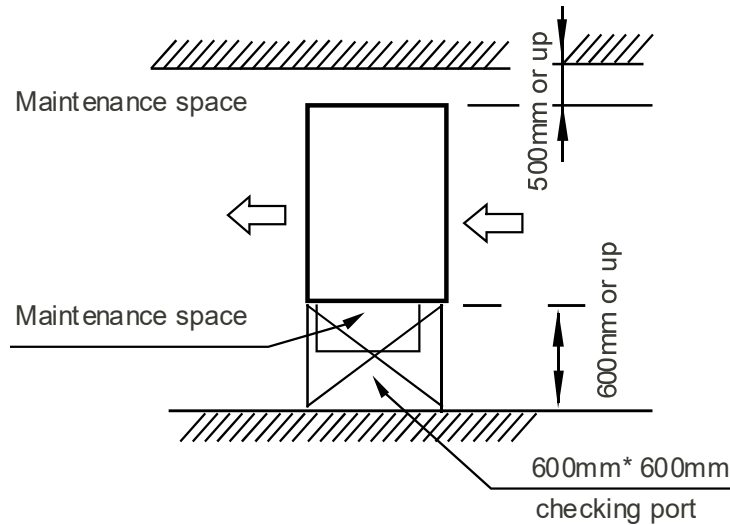

4 Piping Diagram

Figure 4.1: 7.0-56.0kBtu/h Medium Static Pressure Duct piping diagram

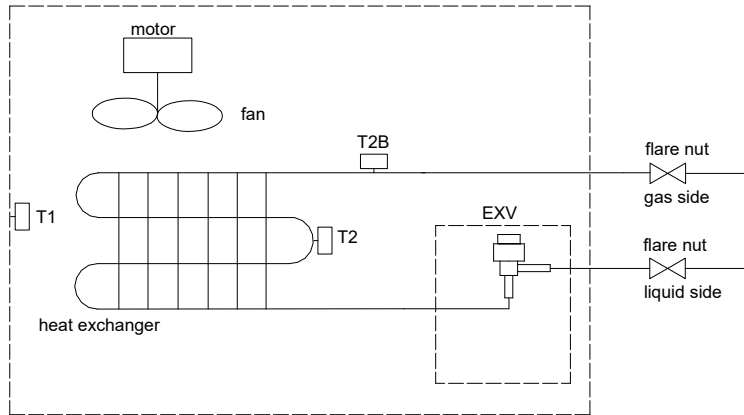

Legend	
T1	Indoor ambient temperature sensor
T2	Indoor heat exchanger mid-point temperature sensor
T2B	Indoor heat exchanger outlet temperature sensor

Ultima Series VRF Indoor Units

5 Wiring Diagram

Figure 5.1: 7.0-48.0kBTu/h Medium Static Pressure Duct wiring diagram

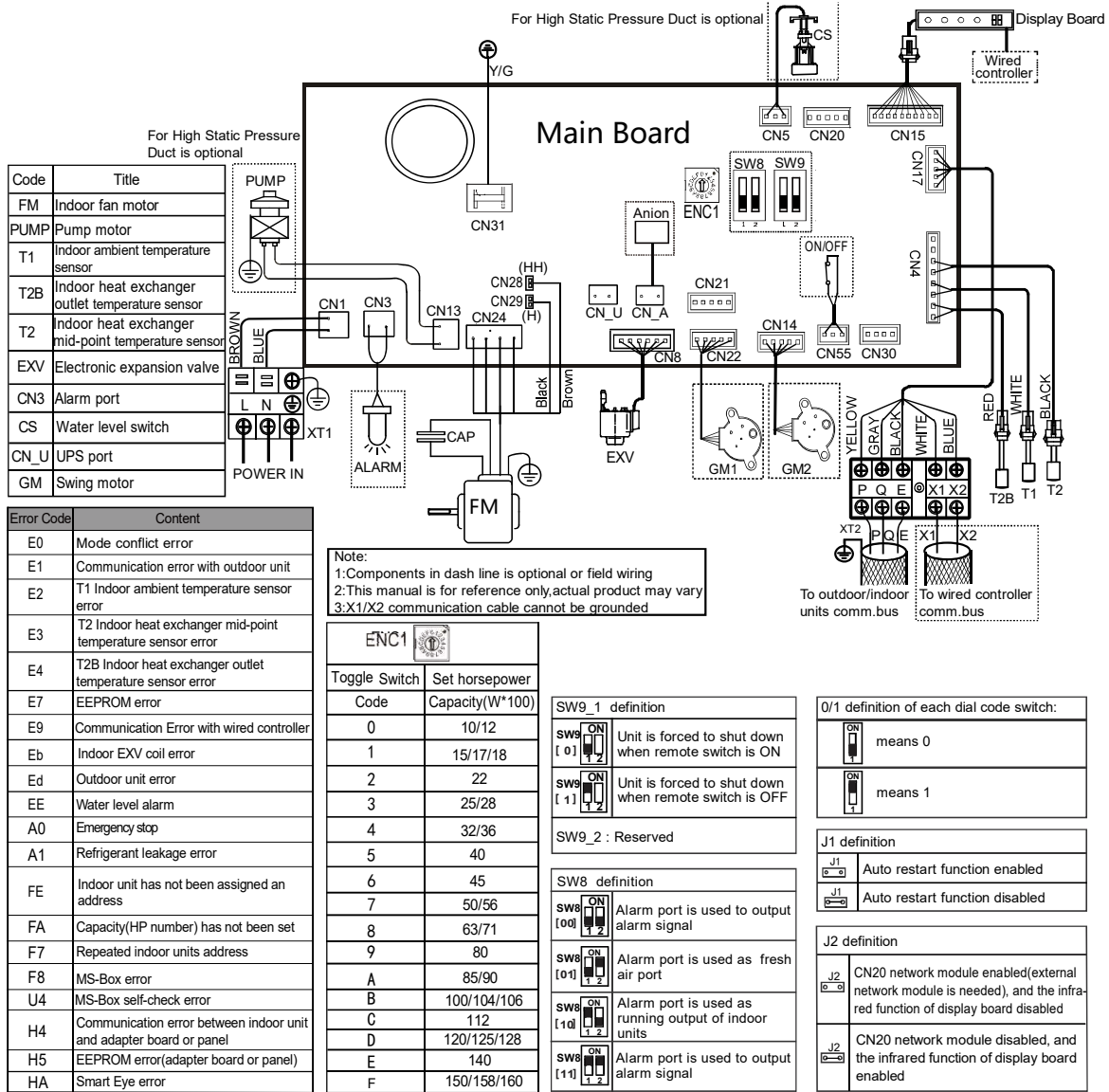

Ultima Series VRF Indoor Units

Figure 5.2: 56.0kbtu/h Medium Static Pressure Duct wiring diagram

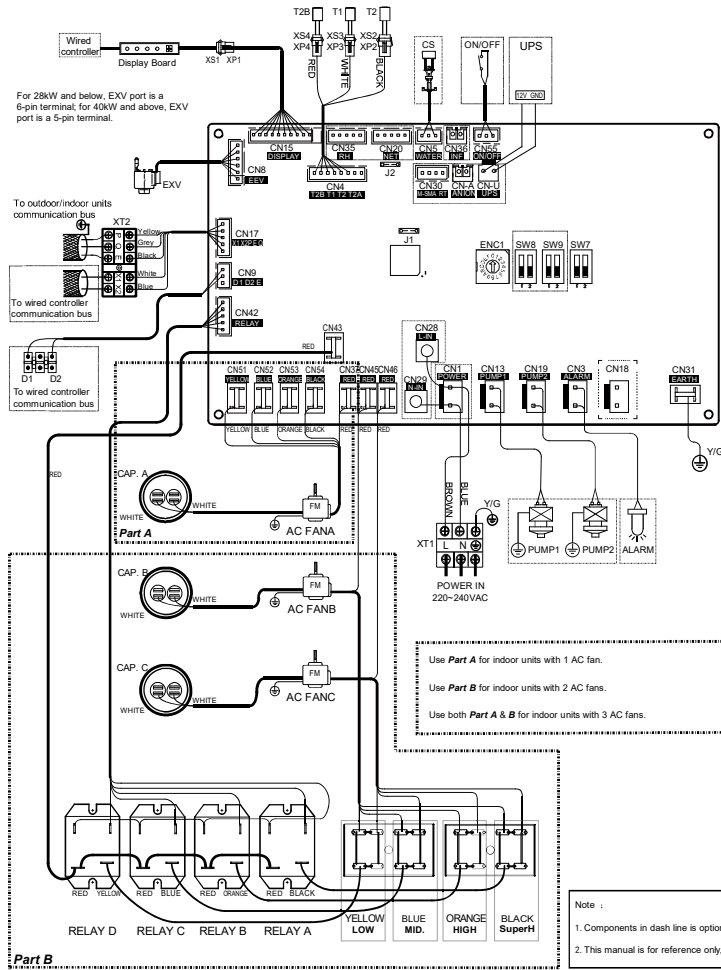

ENC1	sw7	Set Horsepower (x100(W))
Toggle Switch		Capacity
E		140
F		150/158/160

Code	Title
FM	Indoor fan motor
PUMP	Pump motor
T1	Indoor ambient temperature sensor
T2	Indoor heat exchanger mid-point temperature sensor
T2B	Indoor heat exchanger outlet temperature sensor
EXV	Electronic expansion valve
CAP.	Capacitors
XT1-2	Terminals
XP1-4	Connectors
ON/OFF	Remote on/off switch
CS	Water level switch
UPS	Uninterruptible Power Supply

Error Content	Error Code	Factory code
The indoor unit has not been assigned an address	FE	16026000019442
Mode conflict error	E0	Date: 2020.07.21 Revision: A
Communication error with outdoor unit	E1	0/1 definition of each dial code switch:
T1(Indoor ambient) temperature sensor error	E2	SW7_1: Reserved
T2(Indoor heat exchanger mid-point) temperature sensor error	E3	SW7_2 definition
T2B(Indoor heat exchanger outlet) temperature sensor error	E4	sw7 (0) Unit with capacity less than 18kW sw7 (1) Unit with capacity equal or more than 18kW
EEPROM error	E7	SW8 definition (function reserved)
Communication error with wired controller	E9	sw8 (0) Alarm port is used to output alarm signal (default) sw8 (1) Alarm port is used as fresh air port
Outdoor unit error	Ed	sw9 (10) Alarm port is used as running output of indoor units
Indoor EXV coil error	Eb	sw9 (11) Alarm port is used to output alarm signal
Communication error between indoor unit and adapter board or panel	H4	SW9_1 definition (function reserved)
EEPROM error(adapter board or panel)	H5	sw9 (0) Unit is forced to shut down when remote switch is ON(default) sw9 (1) Unit is forced to shut down when remote switch is OFF
Smart Eye error	HA	SW9_2: Reserved
Repeated indoor unit address	F7	J1 definition
MS-Box error	F8	J1 (0) Auto restart function enabled(default) J1 (1) Auto restart function disabled
Refrigerant leakage error	A1	J2 definition
Emergency stop	A0	J2 (0) CN20 network module enabled (external network module is needed), and the infrared function of display board disabled
Water level alarm	EE	J2 (1) CN20 network module disabled, and the infrared function of display board enabled(default)
Capacity(HP number) has not been set	FA	

Ultima Series VRF Indoor Units

6 Fan Performance

6.1 How to Read the Diagram

The vertical axis is the External Static Pressure (Pa) while the horizontal axis represents the Air Flow (m^3/h). The characteristic curve for the "SH," "H," "M," and "L" fan speed control, The nameplate values are shown based on the "H" air flow.

Therefore in the case of 024/027 Model, the air flow is 900 m^3/h , while the External Static Pressure is 80Pa at "H" position. If 90Pa needed, the airflow is at 'SH'.

6.2 Medium Static Pressure Duct fan performance diagram

Table 6.1BELP008(10,12) fan performance diagram

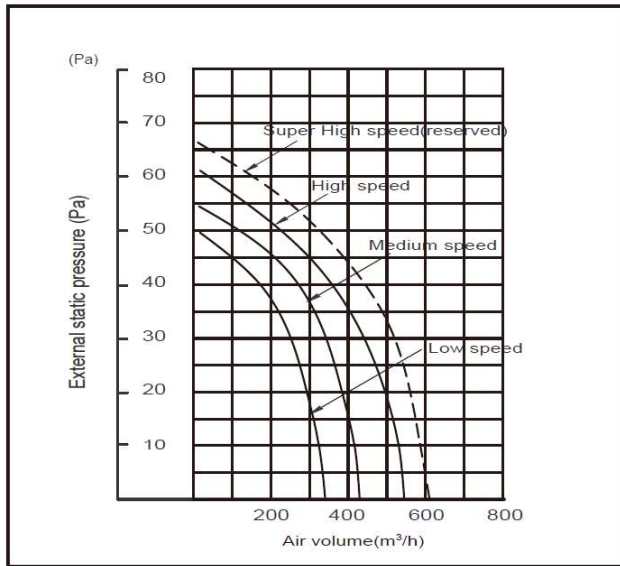

Table 6.3: BEMP024Q3A-DCM071 fan performance diagram

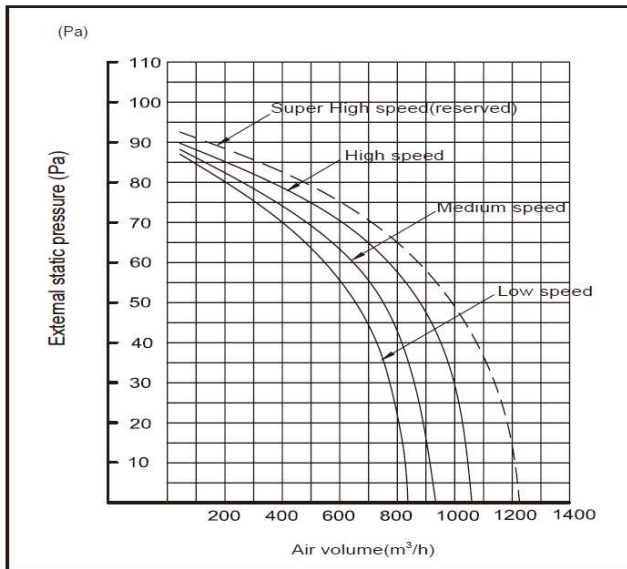

Table 6.2: BELP015(19) fan performance diagram

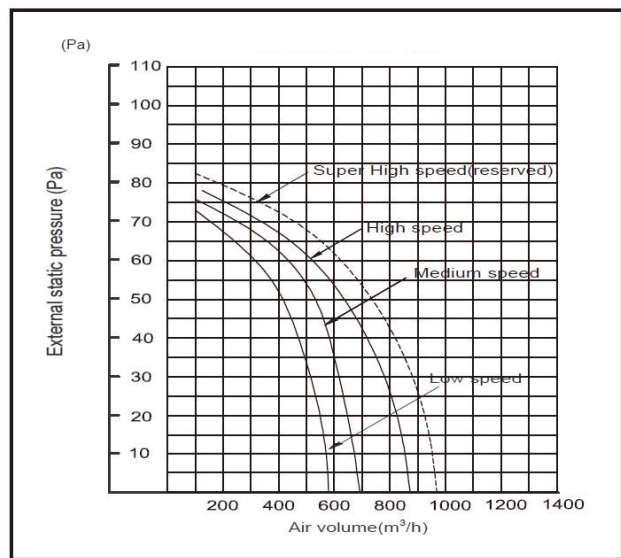
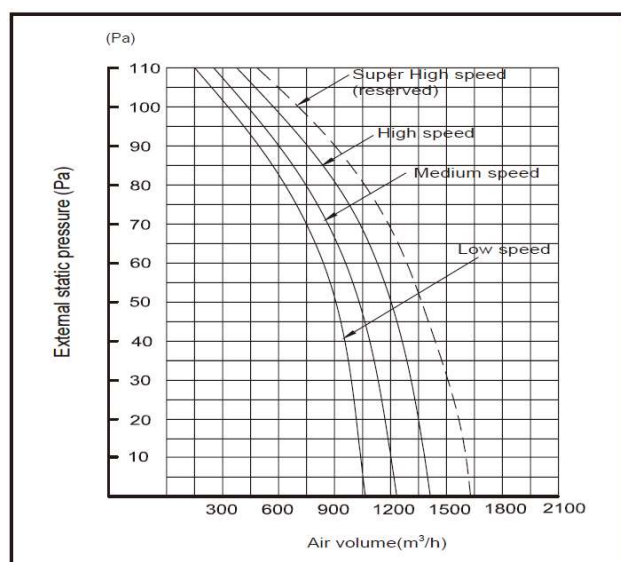

Table 6.4: BEMP028(31) fan performance diagram



Ultima Series VRF Indoor Units

Table 6.5: BEMP038Q3A-DCM112 fan performance diagram

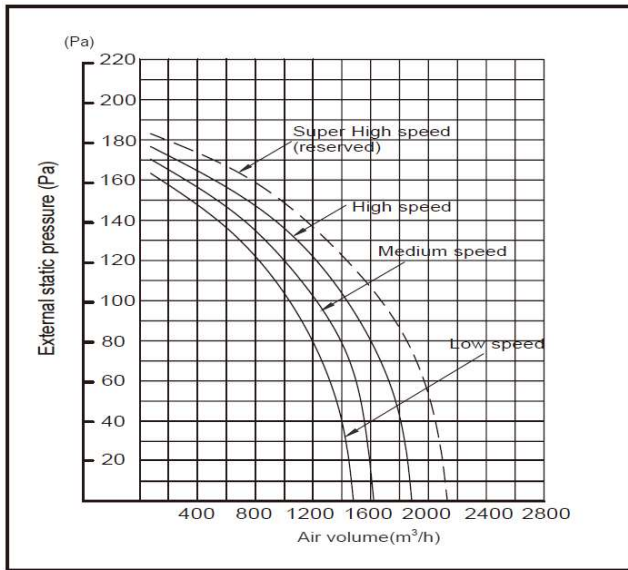

Table 6.6: BEMP048Q3A-DCM140 fan performance diagram

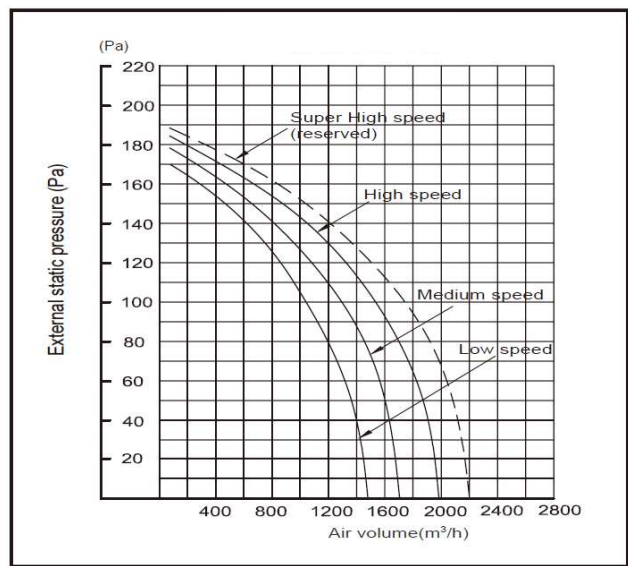
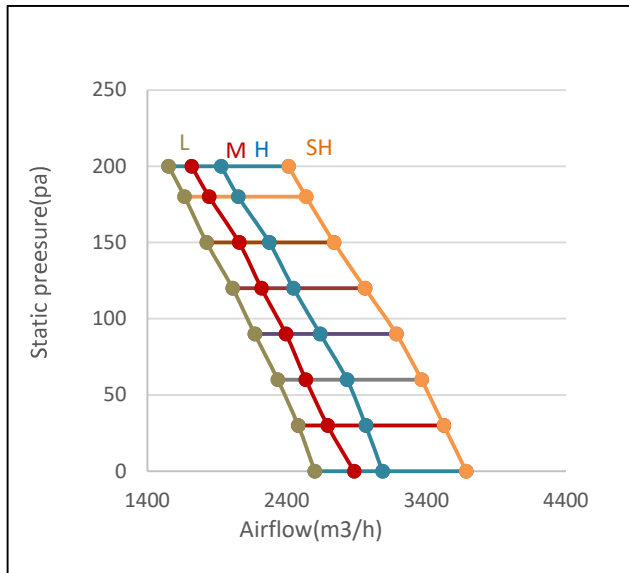

Table 6.7: BEHP060Q3A-DCM160 fan performance diagram



Ultima Series VRF Indoor Units

7 Capacity Tables

7.1 Cooling Capacity Table

Table 7.1: Medium Static Pressure Duct cooling capacity

Model	Indoor air temperature (°C WB/DB)													
	14/20		16/23		18/26		19/27		20/28		22/30		24/32	
	TC	SC	TC	SC	TC	SC	TC	SC	TC	SC	TC	SC	TC	SC
BELP008Q3A-DCM022	2.0	2.0	2.1	2.0	2.2	1.9	2.2	1.9	2.3	1.9	2.3	1.7	2.4	1.7
BELP010Q3A-DCM028	2.5	2.5	2.7	2.5	2.8	2.5	2.8	2.3	2.9	2.3	2.9	2.2	3.0	2.1
BELP012Q3A-DCM036	3.2	3.2	3.4	3.1	3.6	3.1	3.6	3.0	3.7	3.0	3.8	2.8	3.9	2.7
BELP015Q3A-DCM045	4.0	3.9	4.3	3.9	4.5	3.9	4.5	3.7	4.6	3.6	4.7	3.5	4.8	3.3
BELP019Q3A-DCM056	5.0	4.9	5.3	4.8	5.6	4.8	5.6	4.6	5.7	4.5	5.8	4.3	6.0	4.1
BEMP024Q3A-DCM071	6.3	6.2	6.7	6.1	7.0	6.1	7.1	5.9	7.2	5.7	7.4	5.4	7.6	5.2
BEMP027Q3A-DCM080	7.1	6.8	7.6	6.9	7.9	6.8	8.0	6.6	8.1	6.4	8.3	6.1	8.5	5.8
BEMP031Q3A-DCM090	8.0	7.7	8.5	7.7	8.9	7.6	9.0	7.4	9.1	7.1	9.4	6.8	9.6	6.5
BEMP038Q3A-DCM112	9.9	9.6	10.6	9.7	11.1	9.6	11.2	9.2	11.3	8.9	11.6	8.5	11.9	8.2
BEMP048Q3A-DCM140	12.4	12.0	13.2	12.0	13.8	11.9	14.0	11.5	14.2	11.2	14.5	10.6	14.9	10.2
BEHP060Q3A-DCM160	14.2	13.8	15.1	13.7	15.8	13.6	16.0	13.1	16.2	12.7	16.6	12.1	17.0	11.7

Abbreviations:

TC: Total capacity (kW)

SC: Sensible capacity(kW)

Notes:

1. Shaded cells indicate rated condition.

7.2 Heating Capacity Table

Table 7.2: Medium Static Pressure Duct heating capacity

Model	Indoor air temperature (°C DB)					
	16	18	20	21	22	24
	TC	TC	TC	TC	TC	TC
BELP008Q3A-DCM022	2.8	2.8	2.6	2.5	2.4	2.3
BELP010Q3A-DCM028	3.4	3.4	3.2	3.1	3.0	2.8
BELP012Q3A-DCM036	4.2	4.2	4.0	3.8	3.8	3.5
BELP015Q3A-DCM045	5.3	5.3	5.0	4.8	4.7	4.4
BELP019Q3A-DCM056	6.7	6.6	6.3	6.1	5.9	5.5
BEMP024Q3A-DCM071	8.5	8.4	8.0	7.8	7.5	7.0
BEMP027Q3A-DCM080	9.5	9.5	9.0	8.7	8.5	7.8
BEMP031Q3A-DCM090	10.6	10.5	10.0	9.7	9.4	8.8
BEMP038Q3A-DCM112	13.3	13.1	12.5	12.1	11.8	10.9
BEMP048Q3A-DCM140	16.4	16.3	15.5	15.0	14.6	13.5
BEHP060Q3A-DCM160	18.0	17.9	17.0	16.5	16.0	14.8

Abbreviations:

TC: Total capacity (kW)

Notes:

1. Shaded cells indicate rated condition.

8 Electrical Characteristics

Table 8.1: Medium Static Pressure Duct electrical characteristics

Model name	Power supply						Indoor fan motors	
	Hz	Volts	Min. volts	Max. volts	MCA	MFA	Rated motor output (kW)	FLA
BELP008Q3A-DCM022	50	220-240	198	264	0.3	15	0.03	0.2
BELP010Q3A-DCM028	50	220-240	198	264	0.3	15	0.03	0.2
BELP012Q3A-DCM036	50	220-240	198	264	0.3	15	0.03	0.2
BELP015Q3A-DCM045	50	220-240	198	264	0.4	15	0.03	0.3
BELP019Q3A-DCM056	50	220-240	198	264	0.4	15	0.03	0.3
BEMP024Q3A-DCM071	50	220-240	198	264	0.6	15	0.06	0.5
BEMP027Q3A-DCM080	50	220-240	198	264	1.0	15	0.15	0.8
BEMP031Q3A-DCM090	50	220-240	198	264	1.0	15	0.15	0.8
BEMP038Q3A-DCM112	50	220-240	198	264	1.3	15	0.15	1.0
BEMP048Q3A-DCM140	50	220-240	198	264	1.6	15	0.24	1.3
BEHP060Q3A-DCM160	50	220-240	198	264	4.7	15	0.56	3.8

Abbreviations:

MCA: Minimum Circuit Amps

MFA: Maximum Fuse Amps

FLA: Full Load Amps

Ultima Series VRF Indoor Units

9 Sound Levels

9.1 Overall

Table 9.1: Medium Static Pressure Duct sound pressure levels¹

Model name	Sound pressure levels dB(A)		
	H	M	L
BELP008Q3A-DCM022	32	24	21
BELP010Q3A-DCM028	31	24	21
BELP012Q3A-DCM036	35	28	24
BELP015Q3A-DCM045	36	29	26
BELP019Q3A-DCM056	36	29	27
BEMP024Q3A-DCM071	36	30	27
BEMP027Q3A-DCM080	45.4	39.8	37
BEMP031Q3A-DCM090	45.4	39.8	37
BEMP038Q3A-DCM112	48.0	41.9	38
BEMP048Q3A-DCM140	47.7	43.2	39
BEHP060Q3A-DCM160	54	52	50

Notes:

1. Sound pressure levels are measured 1.4m below the unit in a semi-anechoic chamber. During in-situ operation, sound pressure levels may be higher as a result of ambient noise.

Figure 9.1: sound pressure level measurement

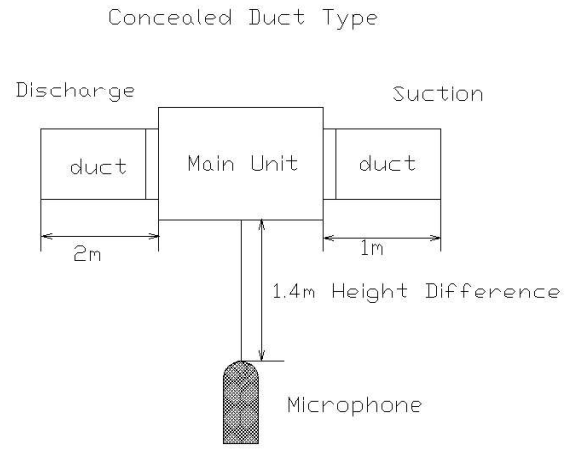

9.2 Octave Band Levels

Figure 9.2: BELP008Q3A-DCM022 octave band levels

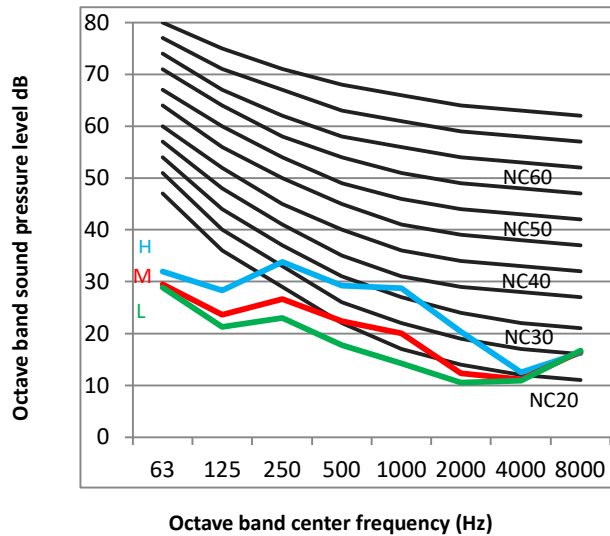
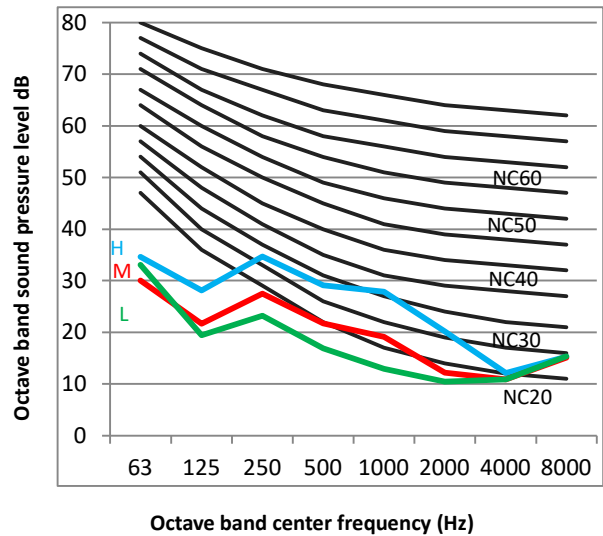

Figure 9.3: BELP010Q3A-DCM028 octave band levels



Ultima Series VRF Indoor Units

Figure 9.4: BELP012Q3A-DCM036 octave band levels

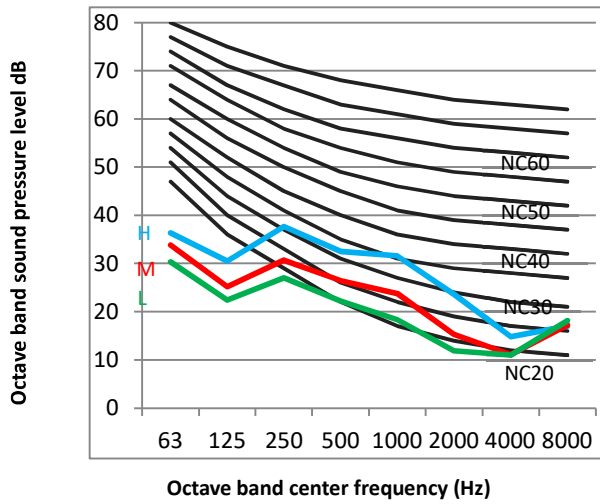

Figure 9.5: BELP015 octave band levels

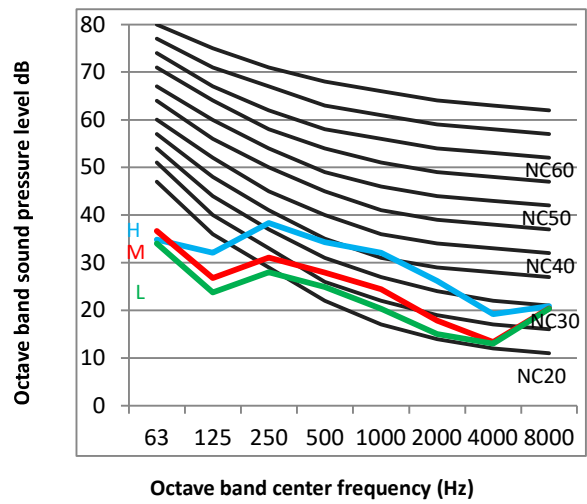

Figure 9.6: BELP019Q3A-DCM056 octave band levels

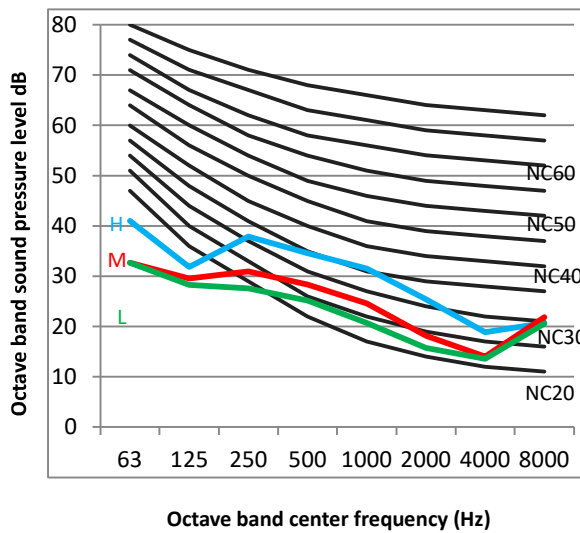

Figure 9.7: BEMP024Q3A-DCM071 octave band levels

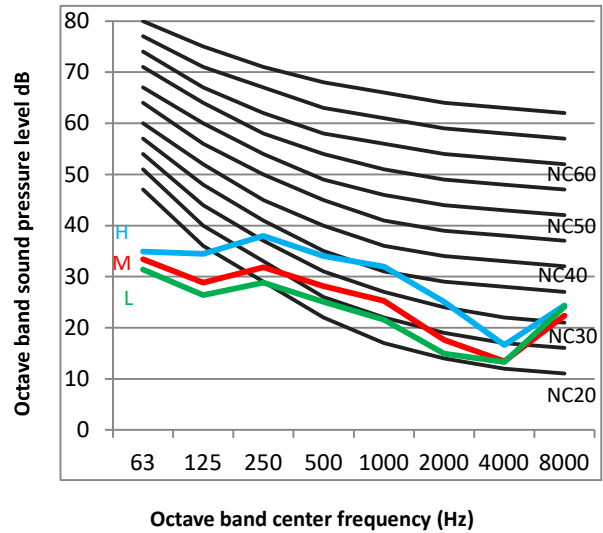

Figure 9.8: BEMP027(31) octave band levels

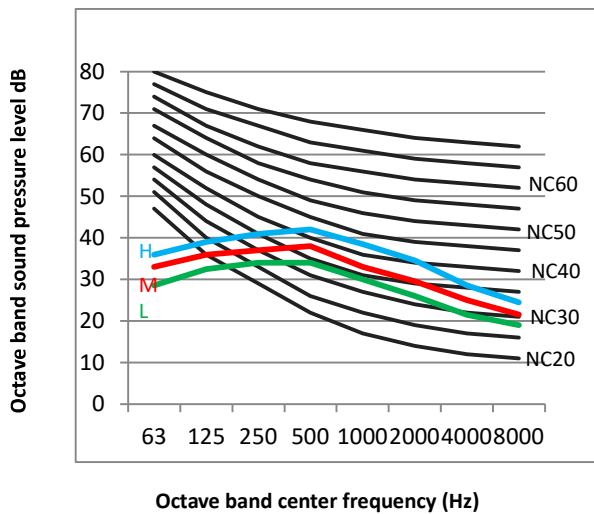
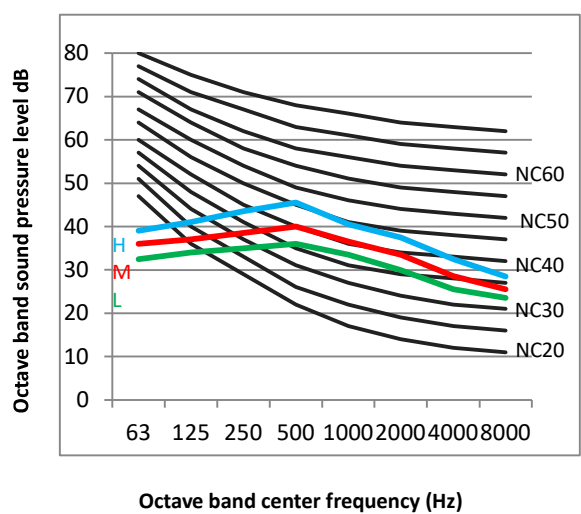

Figure 9.9: BEMP038Q3A-DCM112 octave band levels



Ultima Series VRF Indoor Units

Figure 9.10: BEHP048Q3A-DCM140 octave band levels

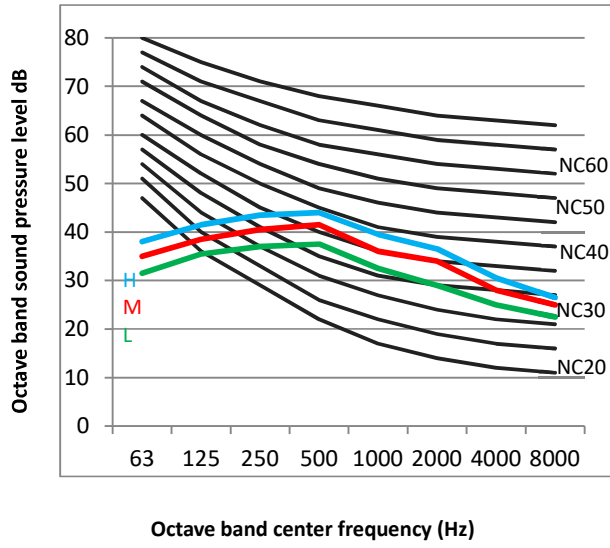
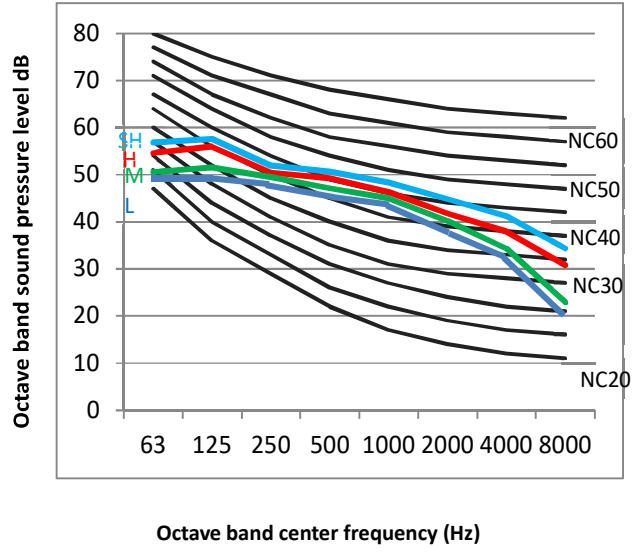

Figure 9.11: BEHP060Q3A-DCM160 octave band levels





OMEGA
ENVIRONMENTAL
TECHNOLOGIES LLC.

17702 Mitchell North, #101
Irvine, CA. 92614 .USA
Tel: 714 795 2830
Fax: 714 966 1646
info@omegainverter.com
www.omegainverter.com

OTECTM
AIR CONDITIONING

Showroom & Technology Center
11380 Interchange Circle North
Miramar, FL 33025 .USA
Tel: 305 901 1270
Fax: 954 212 8280
info@otecomega.com
www.otecomega.com

BELPMPHPQ3A-TM1D0721