

Ultima Series

50Hz Indoor Unit Service Manual

220~240V/1/50Hz

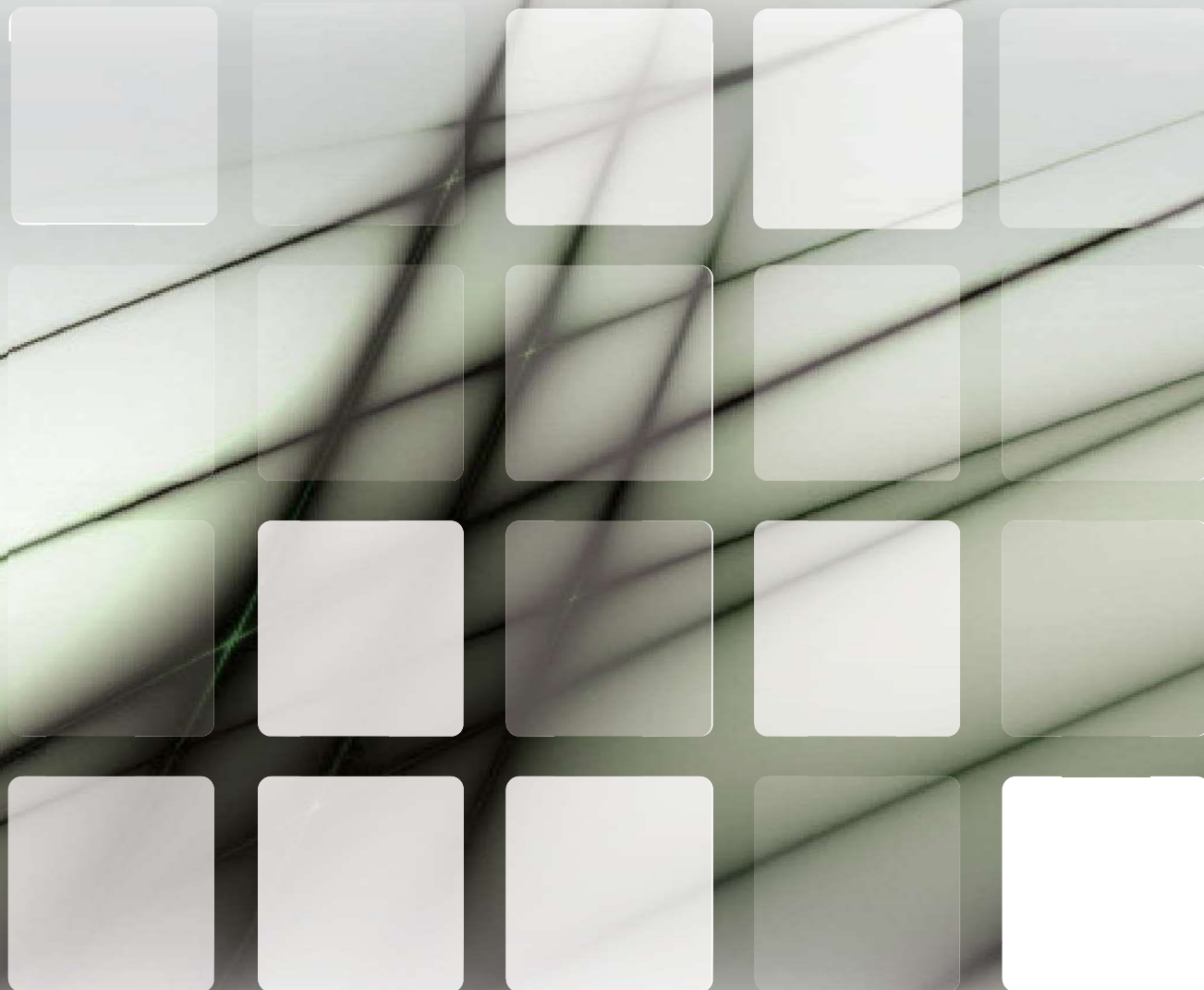

CONTENTS

1 Main PCB Ports	2
2 Indoor Unit Field Settings	18
3 Display Panels	23
4 Control	26
5 Errors	32
6 Troubleshooting	35
7 Appendix.....	59

1 Main PCB Ports

1.1 One-way Cassette and Two-way Cassette

Figure 1.1: One-way Cassette and Two-way Cassette main PCB ports

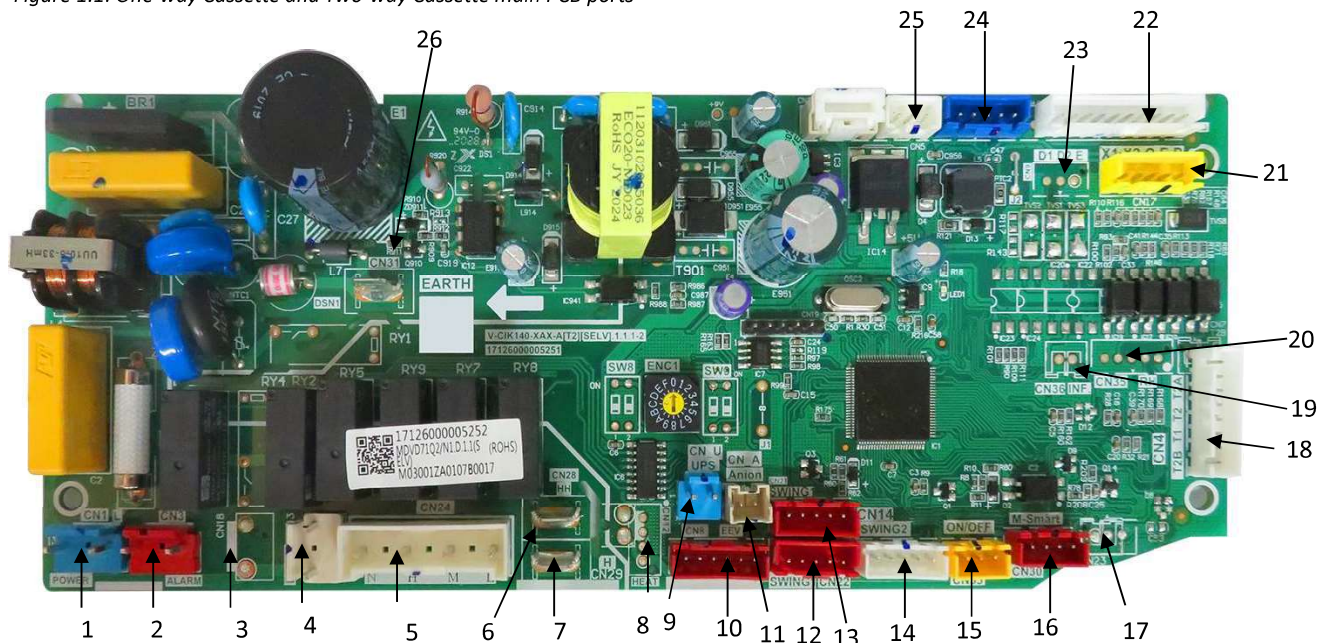

Table 1.1: One-way Cassette and Two-way Cassette main PCB ports

Label in Figure 1.1	Code	Content	Port voltage	Note
1	CN1	AC power input	220V AC	Standard
2	CN3	3 functions can be customized: Alarm/fresh air/operating signal	220V AC	Customized
3	CN18	Reserved	220V AC	/
4	CN13	Drain pump connection	220V AC	Standard
5	CN24	Fan connection	220V AC	Standard
6	CN28	Super-high airflow rate (HH terminal)	220V AC	Standard
7	CN29	High airflow rate (H terminal)	220V AC	Standard
8	CN12	Reserved	12V DC	/
9	CN_U	UPS	12V DC	Customized
10	CN8	EXV control output	12V DC	Standard
11	CN_A	Reserved	12V DC	/
12	CN21	SWING1 connection(up&down)	12V DC	Standard
13	CN22	Reserved	12V DC	/
14	CN14	SWING2 connection(left&right)	12V DC	Standard
15	CN55	Remote ON/OFF Signal input	12V DC	Standard
16	CN30	M-Smart*	12V DC	/
17	CN23	Reserved	5V DC	/
18	CN4	Temperature sensor connection Red: Indoor heat exchanger outlet temperature sensor connection; White: Indoor ambient temperature sensor connection; Black: Indoor heat exchanger mid-point temperature sensor connection;	5V DC	Standard

Table continued on next page ...

Table 1.1: One-way Cassette and Two-way Cassette main PCB ports (continued)

Label in Figure 1.1	Code	Content	Port voltage	Note
19	CN36	Reserved	5V DC	/
20	CN35	Reserved	5V DC	/
21	CN17	X1 X2 Q E P communication port	X1 X2:18V DC ; P Q E:2.5-2.7V DC	Standard
22	CN15	Display panel connection	5V DC	Standard
23	CN9	D1 D2 E communication port	5V DC	Customized
24	CN20	Reserved	5V DC	/
25	CN5	Water level switch connection	12V DC	Standard
26	CN31	EARTH connection	/	

Notes:

Standard: The model has this function, the customers can connect corresponding device through this port, such as water pump and hotel key card etc.

Customized: This function needs to be customized before leaving the factory.

Reserved: This port can not be used.

*: 4 cores port, only standard for four-way cassette individual swing panel and medium static pressure duct smart panel, besides it can also connect UPS device.

1.2 Four-way Cassette

Figure 1.2: Four-way Cassette main PCB ports

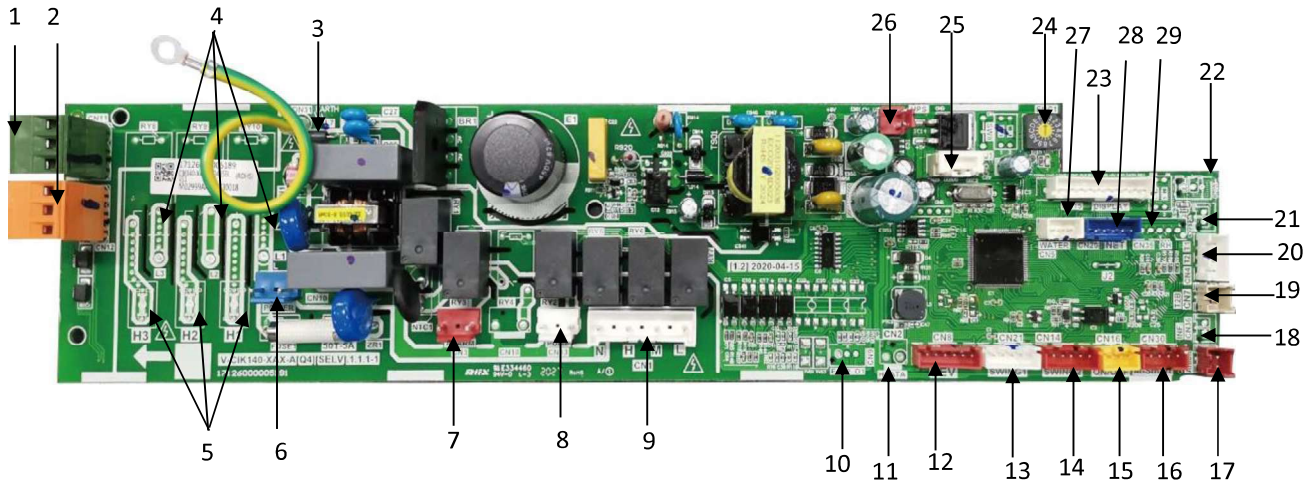

Table 1.2: Four-way Cassette main PCB ports

Label in Figure 1.2	Code	Content	Port voltage	Note
1	CN11	P Q E communication port	2.5-2.7V DC	Standard
2	CN12	X1 X2 communication port	18V DC	Standard
3	CN31	Ground port		Standard
4	L1/L2/L3	4-position terminal block	380V AC	Customized
5	H1/H2/H3	E-heater connection port	380V AC	Customized
6	CN10	AC power input	220V AC	Standard
7	CN3	3 functions can be customized: Alarm/fresh air/operating signal	220V AC	Customized
8	CN13	Pump drive port	220V AC	Standard
9	CN1	Fan connection	220V AC	Standard
10	CN9	D1 D2 E communication port	5V DC	Customized
11	CN2	Thermo switch connection port(cooperate with E-heat)	12V DC	Customized
12	CN8	EEV drive port	12V DC	Standard
13	CN21	SWING MOTOR SWING1 control output	12V DC	Standard
14	CN14	Reserved	12V DC	/
15	CN16	Remote on/off switch connection	5V DC	Customized
16	CN30	M-Smart port*	12V DC	/
17	CN_A	Reserved	12V DC	/
18	CN36	/	5V DC	/
19	CN7	T2B sensor connection port	5V DC	Standard
20	CN4	Temperature sensor connection Red: Indoor heat exchanger outlet temperature sensor connection; White: Indoor ambient temperature sensor connection; Black: Indoor heat exchanger mid-point temperature sensor connection;	5V DC	Standard
21	CN22	Reserved	5V DC	/
22	CN23	Reserved	2.5-2.7V DC	/
23	CN15	Display panel connection	2.5-2.7V DC	Standard

Table continued on next page ...

Table 1.2: Four-way Cassette main PCB ports (continued)

Label in Figure 1.2	Code	Content	Port voltage	Note
24	ENC1	Capacity dial switch	5V DC	Standard
25	CN25	DEBUG port	5V DC	Standard
26	CN_U	UPS port	12V DC	Customized
27	CN5	Water level switch connection	5V DC	Standard
28	CN20	Reserved	5V DC	/
29	CN35	/	5V DC	/

Notes:

Standard: The model has this function, the customers can connect corresponding device through this port, such as water pump and hotel key card etc.

Customized: This function needs to be customized before leaving the factory.

Reserved: This port can not be used.

*: 4 cores port, only standard for four-way cassette individual swing panel and medium static pressure duct smart panel, besides it can also connect UPS device.

1.3 Compact Four-way Cassette

Figure 1.3: Compact Four-way Cassette main PCB ports

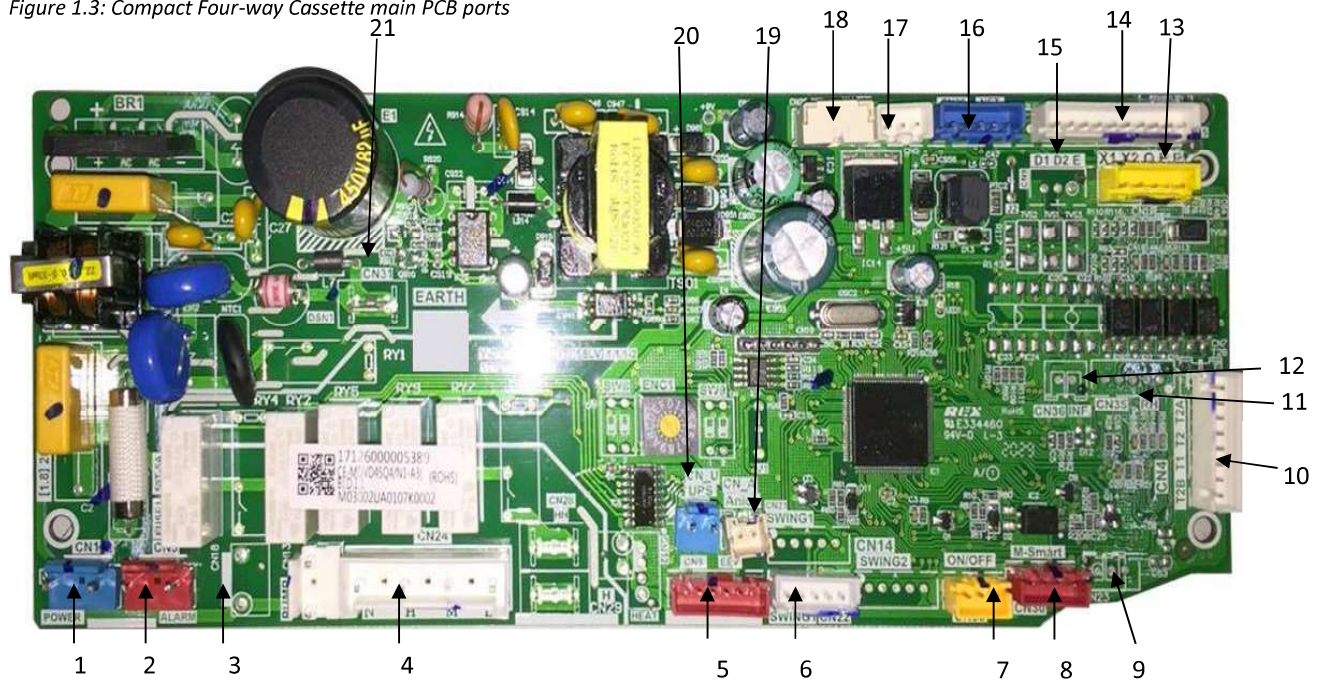

Table 1.3: Compact Four-way Cassette main PCB ports

Label in Figure 1.3	Code	Content	Port voltage	Note
1	CN1	AC power input	220V AC	Standard
2	CN3	3 functions can be customized: Alarm/fresh air/operating signal	220V AC	Customized
3	CN13	Pump drive port	220V AC	Standard
4	CN24	Fan connection	220V AC	Standard
5	CN8	EEV drive port	12V DC	Standard
6	CN22	SWING MOTOR control output	12V DC	Standard
7	CN55	Remote on/off switch connection	12V DC	Customized
8	CN30	M-Smart port*	12V DC	/
9	CN23	Reserved	5V DC	/
10	CN4	Temperature sensor connection Red: Indoor heat exchanger outlet temperature sensor connection; White: Indoor ambient temperature sensor connection; Black: Indoor heat exchanger mid-point temperature sensor connection;	5V DC	Standard
11	CN35	Reserved	5V DC	/
12	CN36	Reserved	5V DC	/
13	CN17	X1 X2/P Q communication port	18/5V DC	Standard
14	CN15	Display panel connection	5V DC	Standard
15	CN9	D1 D2 E communication port	5V DC	Customized
16	CN20	Reserved	5V DC	/
17	CN5	Water level switch connection	5V DC	Standard
18	CN25	DEBUG port	5V DC	Standard
19	CN_A	Reserved	12V DC	/
20	CN_U	UPS port	12V DC	Customized
21	CN31	Ground port		Standard

Notes:

Standard: The model has this function, the customers can connect corresponding device through this port, such as water pump and hotel key card etc.

Customized: This function needs to be customized before leaving the factory.

Reserved: This port can not be used.

*: 4 cores port, only standard for four-way cassette individual swing panel and medium static pressure duct smart panel, besides it can also connect UPS device.

1.4 Medium Static Pressure Duct

Figure 1.4: Medium Static Pressure Duct main PCB ports

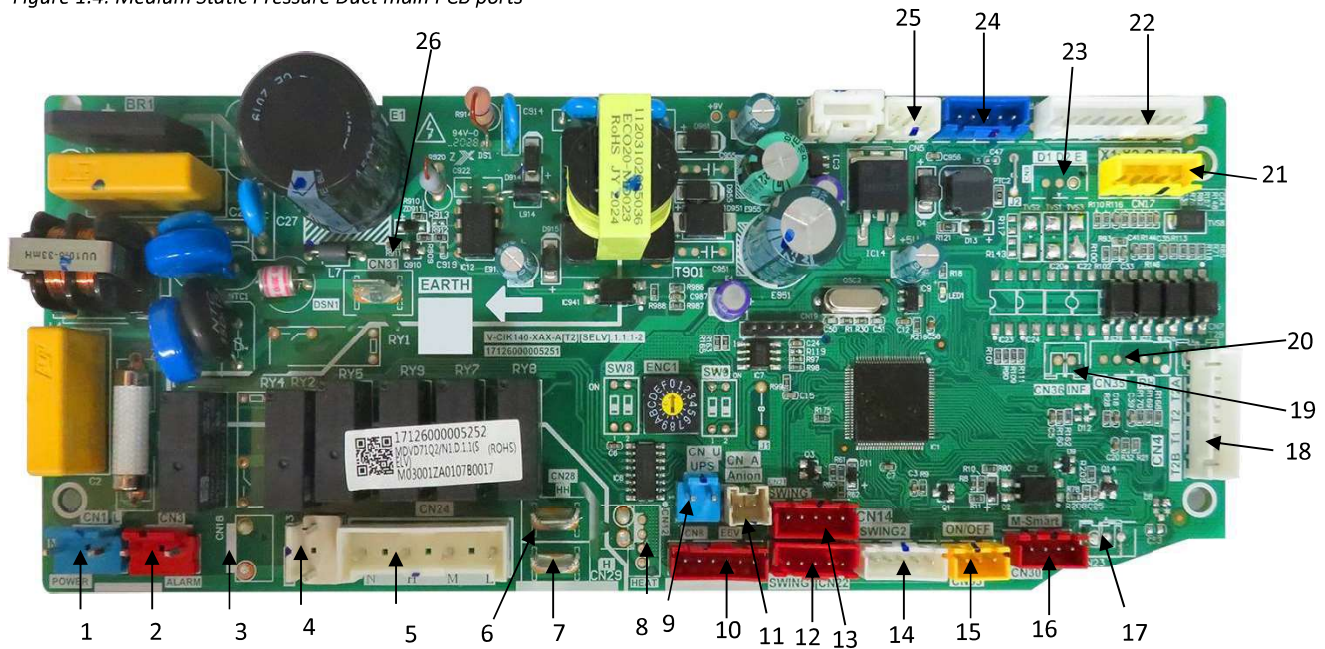

Table 1.4: Medium Static Pressure Duct main PCB ports

Label in Figure 1.4	Code	Content	Port voltage	Note
1	CN1	AC power input	220V AC	Standard
2	CN3	3 functions can be customized: Alarm/fresh air/operating signal	220V AC	Customized
3	CN18	Reserved	220V AC	/
4	CN13	Drain pump connection	220V AC	Standard
5	CN24	Fan connection	220V AC	Standard
6	CN28	Super-high airflow rate (HH terminal)	220V AC	Standard
7	CN29	High airflow rate (H terminal)	220V AC	Standard
8	CN12	Reserved	12V DC	/
9	CN_U	UPS	12V DC	Customized
10	CN8	EXV control output	12V DC	Standard
11	CN_A	Reserved	12V DC	/
12	CN21	SWING1 connection(up&down)	12V DC	Standard
13	CN22	Reserved	12V DC	/
14	CN14	Reserved	12V DC	/
15	CN55	Reserved	12V DC	/
16	CN30	M-Smart*	12V DC	/
17	CN23	Reserved	5V DC	/
18	CN4	Temperature sensor connection Red: Indoor heat exchanger outlet temperature sensor connection; White: Indoor ambient temperature sensor connection; Black: Indoor heat exchanger mid-point temperature sensor connection;	5V DC	Standard
19	CN36	Reserved	5V DC	/
20	CN35	Reserved	5V DC	/

Table continued on next page ...

Table 1.4: Medium Static Pressure Duct main PCB ports (continued)

Label in Figure 1.4	Code	Content	Port voltage	Note
21	CN17	X1 X2 Q E P communication port	X1 X2:18V DC ; P Q E:2.5-2.7V DC	Standard
22	CN15	Display panel connection	5V DC	Standard
23	CN9	D1 D2 E communication port	5V DC	Customized
24	CN20	NET connection port(Cut the J2 jump line)	5V DC	Standard
25	CN5	Water level switch connection	12V DC	Standard
26	CN31	EARTH connection	/	Standard

Notes:

Standard: The model has this function, the customers can connect corresponding device through this port, such as water pump and hotel key card etc.

Customized: This function needs to be customized before leaving the factory.

Reserved: This port can not be used.

*: 4 cores port, only standard for four-way cassette individual swing panel and medium static pressure duct smart panel, besides it can also connect UPS device.

1.5 High Static Pressure Duct

Figure 1.5: Medium Static Pressure Duct main PCB ports (Model 71-112)

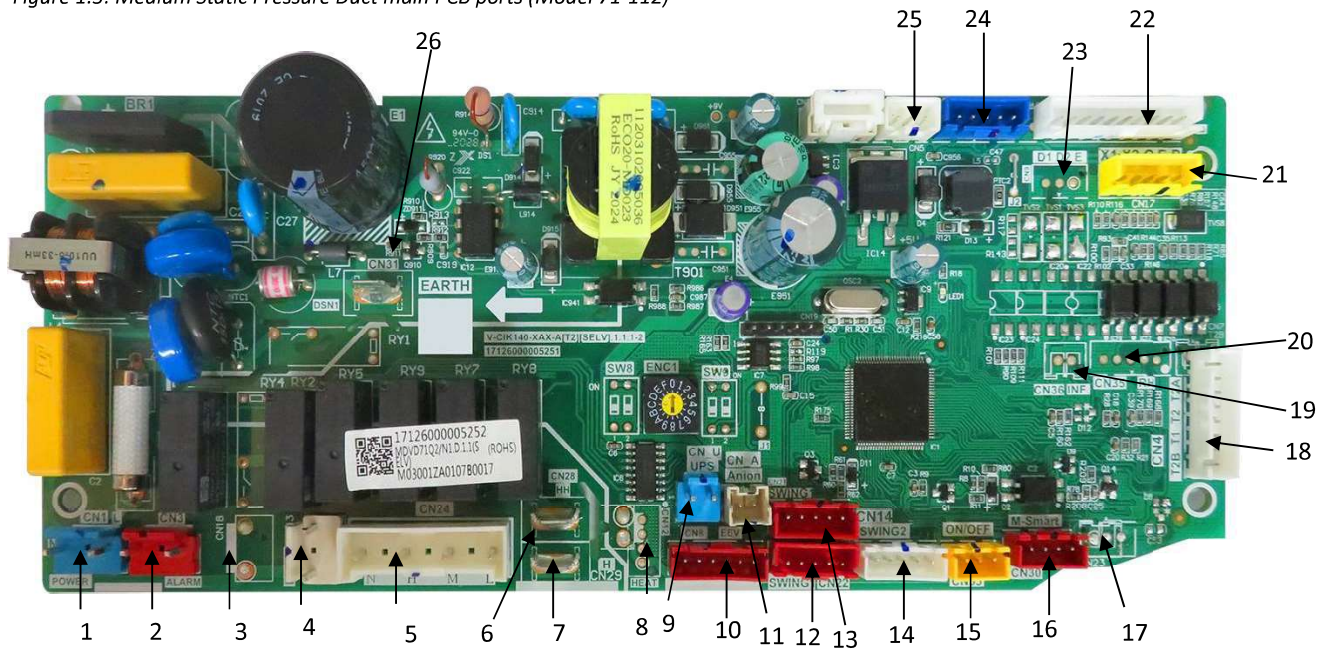

Table 1.5: Medium Static Pressure Duct main PCB ports (Model 71-112)

Label in Figure 1.5	Code	Content	Port voltage	Note
1	CN1	AC power input	220V AC	Standard
2	CN3	3 functions can be customized: Alarm/fresh air/operating signal	220V AC	Customized
3	CN18	Anion connection ¹	220V AC	Customized
4	CN13	Drain pump connection	220V AC	Standard
5	CN24	Fan connection	220V AC	Standard
6	CN28	Super-high airflow rate (HH terminal)	220V AC	Standard
7	CN29	High airflow rate (H terminal)	220V AC	Standard
8	CN12	Reserved	12V DC	/
9	CN_U	UPS	12V DC	Customized
10	CN8	EXV control output	12V DC	Standard
11	CN_A	Reserved	12V DC	/
12	CN21	SWING1 connection(up&down)	12V DC	Standard
13	CN22	Reserved	12V DC	/
14	CN14	SWING2 connection(left&right)	12V DC	Standard
15	CN55	Remote ON/OFF Signal input	12V DC	Standard
16	CN30	M-Smart*	12V DC	/
17	CN23	Reserved	5V DC	/
18	CN4	Temperature sensor connection Red: Indoor heat exchanger outlet temperature sensor connection; White: Indoor ambient temperature sensor connection; Black: Indoor heat exchanger mid-point temperature sensor connection;	5V DC	Standard
19	CN36	Reserved	5V DC	/
20	CN35	Reserved	5V DC	/

Table continued on next page ...

Table 1.5: Medium Static Pressure Duct main PCB ports (Model 71-112) (continued)

Label in Figure 1.5	Code	Content	Port voltage	Note
21	CN17	X1 X2 Q E P communication port	X1 X2:18V DC ; P Q E:2.5-2.7V DC	Standard
22	CN15	Display panel connection	5V DC	Standard
23	CN9	D1 D2 E communication port	5V DC	Customized
24	CN20	Reserved	12V DC	/
25	CN5	Water level switch connection	12V DC	Standard
26	CN31	EARTH connection	/	

Notes:

1. It can be customized to connect Sterilization box.

Standard: The model has this function, the customers can connect corresponding device through this port, such as water pump and hotel key card etc.

Customized: This function needs to be customized before leaving the factory.

Reserved: This port can not be used.

*: 4 cores port, only standard for four-way cassette individual swing panel and medium static pressure duct smart panel, besides it can also connect UPS device.

Figure 1.6: High Static Pressure Duct main PCB ports (Model 140-560)

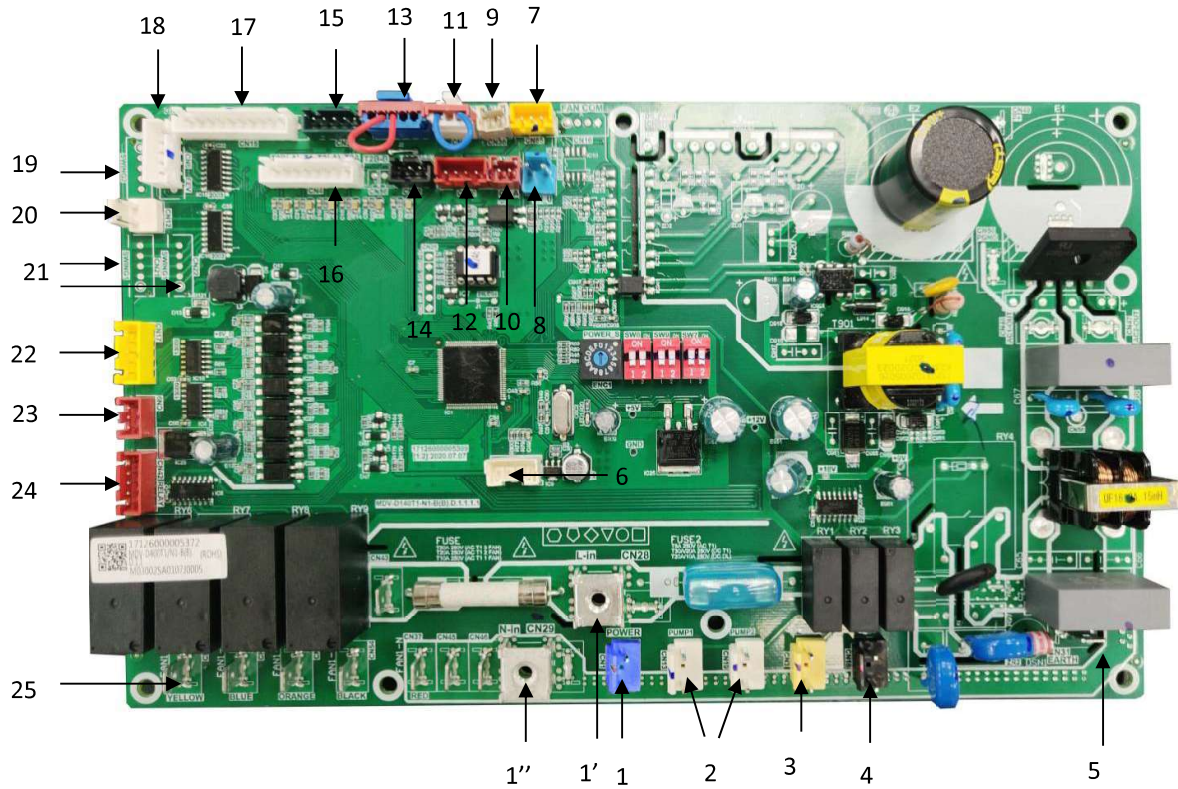

Table 1.6: High Static Pressure Duct main PCB ports (Model 140-560)

Label in Figure 1.6	Code	Content	Port voltage	Note
1	CN1	Total power input(140-160 Standard configuration)	220~240V AC	Standard
1'	CN28	Power input terminal L-in(200-560 Standard configuration)	220~240V AC	Standard
1''	CN29	Power input terminal N-in(200-560 Standard configuration)	220~240V AC	Standard
2	CN13,CN19	Pump 1 and pump 2 control output port	220~240V AC	Standard
3	CN3	3 functions can be customized: Alarm/fresh air/operating signal	220V AC	Customized
4	CN18	Strong electricity sterilization output ¹	220~240V AC	Customized
5	CN31	Main board ground wire	/	Standard
6	CN25	Program burning port DEBUG	5V DC	Standard
7	CN55	Remote ON/OFF Signal input	12V DC	Customized
8	CN_U	UPS	12V DC	Customized
9	CN36	Reserved	5V DC	/
10	CN_A	Reserved	12V DC	/
11	CN5	Water level switch signal input	5V DC	Customized
12	CN30	M-Smart port*	12V DC	/
13	CN20	Reserved	5V DC	/
14	CN23	Reserved	5V DC	/
15	CN14	Reserved	5V DC	/
16	CN4	Temperature sensor T2B/T1/T2/T2A input	5V DC	Standard
17	CN15	Display board interface	5V DC	Standard
18	CN8	EXV control output(6 pin red) (140-280 Standard configuration)	12V DC	Standard
18/	CN8	EXV control output(5 pin red) (400-560 Standard configuration)		Standard

Table continued on next page ...

Table 1.6: High Static Pressure Duct main PCB ports (continued)

Label in Figure 1.6	Code	Content	Port voltage	Note
19	CN14	Reserved	12V DC	/
20	CN12	Reserved	12V DC	/
21	CN21 & CN22	Reserved	12V DC	/
22	CN17	Communication terminal (X1X2 carrier wired control / 485 indoor units and outdoor units communication)	(X1X2)18/(QEP)5V DC	Standard
23	CN9	D1 D2 E communication port	5V DC	Customized
24	CN42	External relay control output (400-560 Standard configuration)	12V DC	Standard
25	CN51,CN52,CN53,CN54,CN43,CN37,CN45,CN46	Fan motor wiring (140-560 Standard configuration, it depends on the model)	220~240V AC	Standard

Notes:

1. It can be customized to connect Sterilization box.

Standard: The model has this function, the customers can connect corresponding device through this port, such as water pump and hotel key card etc.

Customized: This function needs to be customized before leaving the factory.

Reserved: This port can not be used.

*: 4 cores port, only standard for four-way cassette individual swing panel and medium static pressure duct smart panel, besides it can also connect UPS device.

1.6 Ceiling & Floor

Figure 1.7: Ceiling & Floor main PCB ports

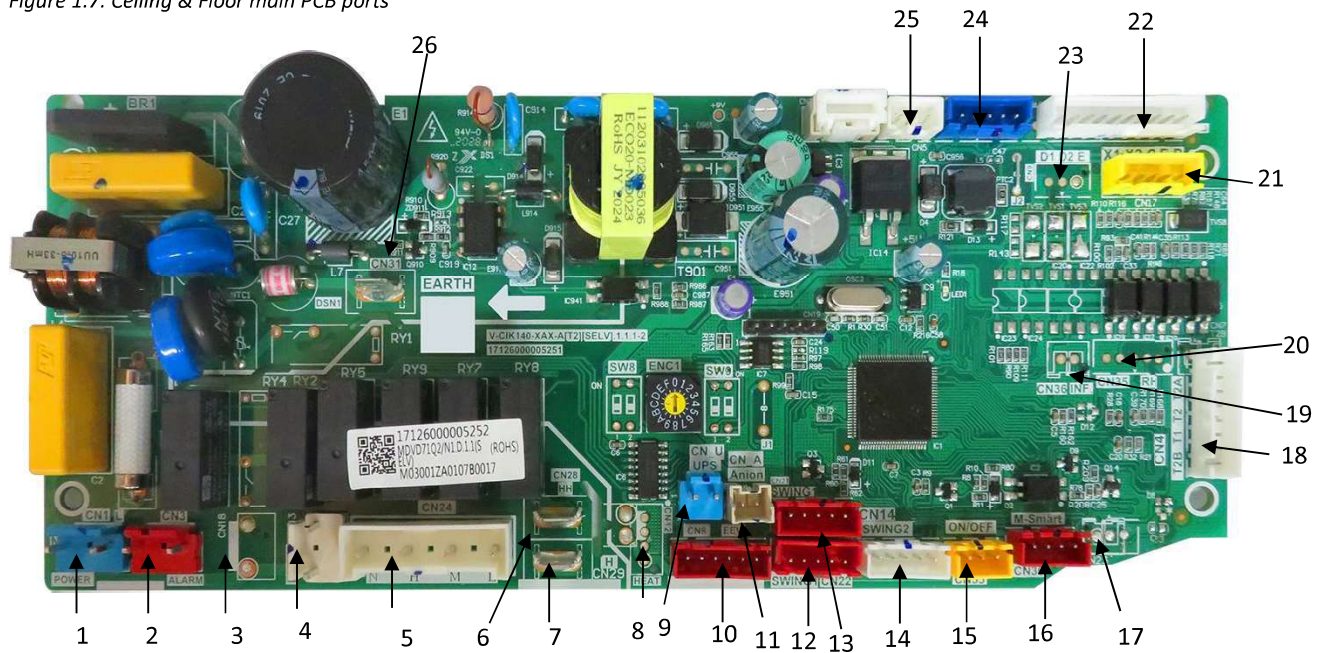

Table 1.7: Ceiling & Floor main PCB ports

Label in Figure 1.7	Code	Content	Port voltage	Note
1	CN1	AC power input	220V AC	Standard
2	CN3	3 functions can be customized: Alarm/fresh air/operating signal	220V AC	Customized
3	CN18	Reserved	220V AC	/
4	CN13	Drain pump connection	220V AC	Standard
5	CN24	Fan connection	220V AC	Standard
6	CN28	Super-high airflow rate (HH terminal)	220V AC	Standard
7	CN29	High airflow rate (H terminal)	220V AC	Standard
8	CN12	Reserved	12V DC	/
9	CN_U	UPS	12V DC	Customized
10	CN8	EXV control output	12V DC	Standard
11	CN_A	Reserved	12V DC	/
12	CN21	SWING1 connection(up&down)	12V DC	Standard
13	CN22	Reserved	12V DC	/
14	CN14	SWING2 connection(left&right)	12V DC	Standard
15	CN55	Remote ON/OFF Signal input	12V DC	Standard
16	CN30	M-Smart*	12V DC	/
17	CN23	Reserved	5V DC	/
18	CN4	Temperature sensor connection Red: Indoor heat exchanger outlet temperature sensor connection; White: Indoor ambient temperature sensor connection; Black: Indoor heat exchanger mid-point temperature sensor connection;	5V DC	Standard
19	CN36	Reserved	5V DC	/
20	CN35	Reserved	5V DC	/

Table continued on next page ...

Table 1.7: Ceiling & Floor main PCB ports (continued)

Label in Figure 1.7	Code	Content	Port voltage	Note
21	CN17	X1 X2 Q E P communication port	X1 X2:18V DC ; P Q E:2.5-2.7V DC	Standard
22	CN15	Display panel connection	5V DC	Standard
23	CN9	D1 D2 E communication port	5V DC	Customized
24	CN20	Reserved	12V DC	/
25	CN5	Water level switch connection	12V DC	Standard
26	CN31	EARTH connection	/	

Notes:

Standard: The model has this function, the customers can connect corresponding device through this port, such as water pump and hotel key card etc.

Customized: This function needs to be customized before leaving the factory.

Reserved: This port can not be used.

*: 4 cores port, only standard for four-way cassette individual swing panel and medium static pressure duct smart panel, besides it can also connect UPS device.

1.7 Wall-mounted Unit

Figure 1.8: Wall-mounted Unit main PCB ports (Model 22/28/36)

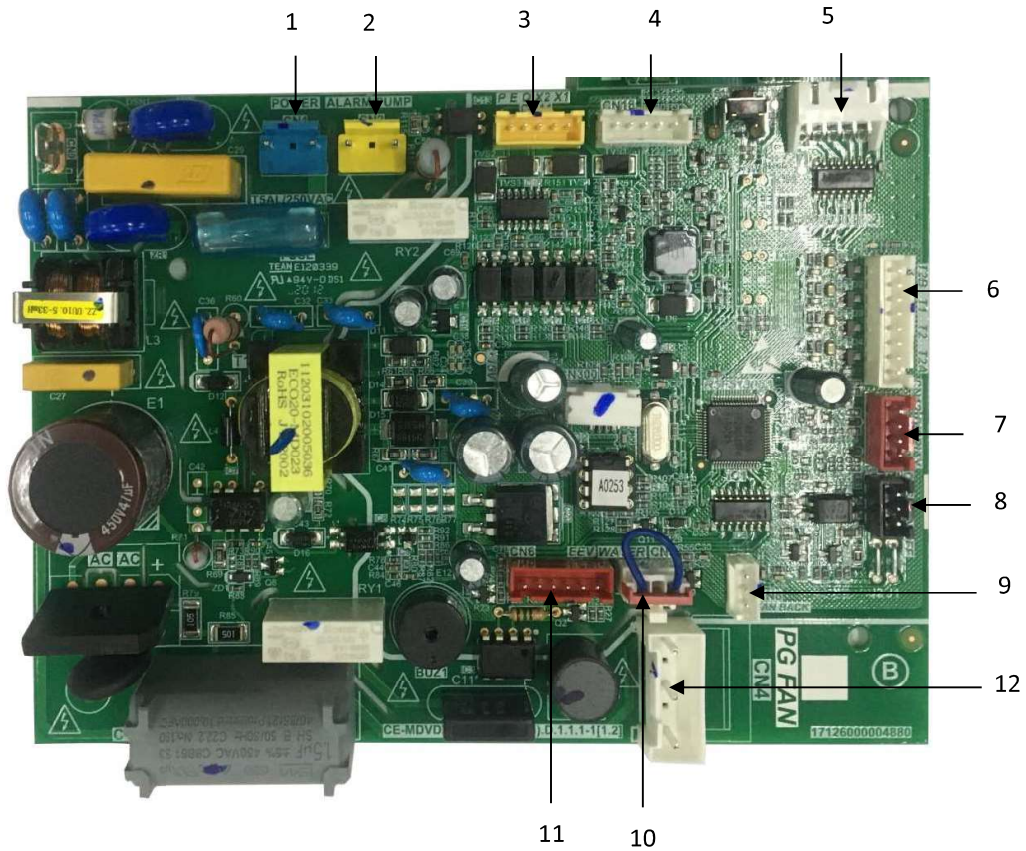

Table 1.8: Wall-mounted Unit main PCB ports (Model 22/28/36)

Label in Figure 1.8	Code	Content	Port voltage	Note
1	CN1	AC power input	220V AC	Standard
2	CN2	ALARM/Pump drive port	220V AC	Customized
3	CN18	X1 X2 communication port	18V DC	Customized
		P Q E communication port	2.5-2.7V DC	Standard
4	CN8	Capability dial switch connection port		Standard
5	CN13	Vertical louver	12V DC	Standard
6	CN19	Red: Indoor heat exchanger outlet temperature sensor connection; White: Indoor ambient temperature sensor connection; Black: Indoor heat exchanger mid-point temperature sensor connection;	5V DC	Standard
7	CN12	Display panel connection	5V DC	Standard
8	CN55	Remote on/off switch connection	12V DC	Standard
9	CN8	PG FAN Back	12V DC	Standard
10	CN5	Water level switch connection	5V DC	Standard
11	CN6	EEV drive port	12V DC	Standard
12	CN4	PG Fan connection	220V AC	Standard

Notes:

Standard: The model has this function, the customers can connect corresponding device through this port, such as water pump and hotel key card etc.

Customized: This function needs to be customized before leaving the factory.

Reserved: This port can not be used.

Figure 1.9: Wall-mounted Unit main PCB ports (Model 45/56)

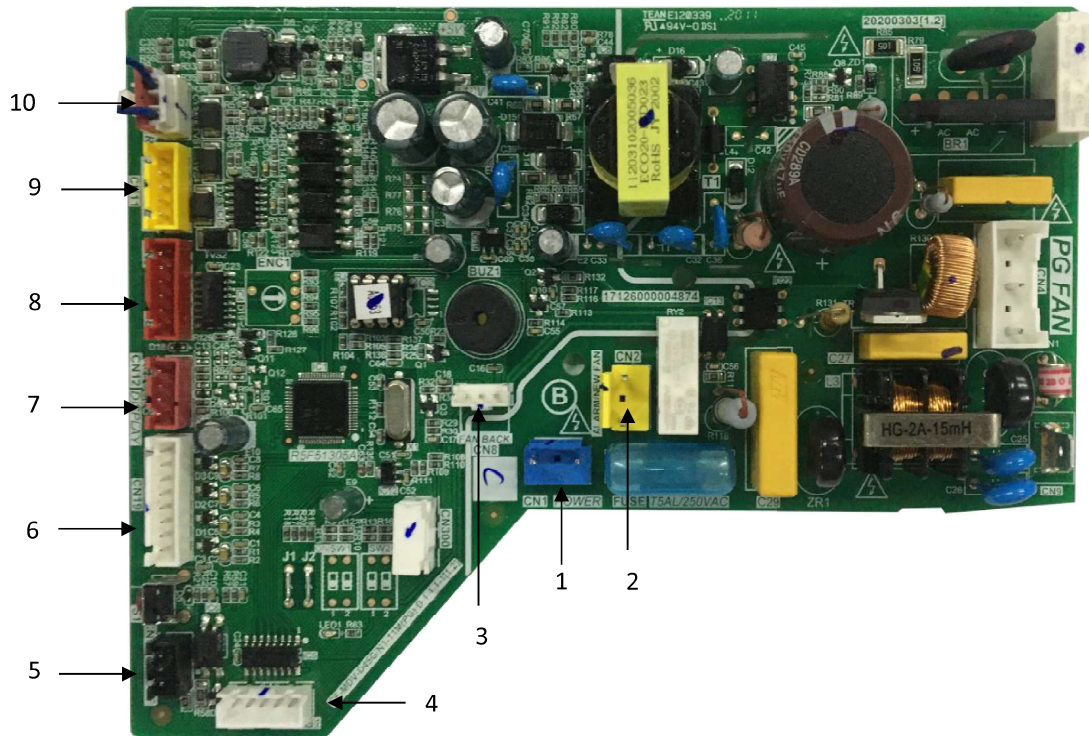

Table 1.9: Wall-mounted Unit main PCB ports (Model 45/56)

Label in Figure 1.9	Code	Content	Port voltage	Note
1	CN1	AC power input	220V AC	Standard
2	CN2	ALARM/Pump drive port	220V AC	Customized
3	CN8	PG FAN Back	12V DC	Standard
4	CN13	Vertical louver	12V DC	Standard
5	CN55	Remote on/off switch connection	12V DC	Standard
6	CN19	Red: Indoor heat exchanger outlet temperature sensor connection; White: Indoor ambient temperature sensor connection; Black: Indoor heat exchanger mid-point temperature sensor connection;	5V DC	Standard
7	CN12	Display panel connection	5V DC	Standard
8	CN6	EEV drive port	12V DC	Standard
9	CN18	X1 X2 communication port	18V DC	Customized
		P Q E communication port	2.5-2.7V DC	Standard
10	CN5	Water level switch connection	5V DC	Standard
11	CN4	PG Fan connection	220V AC	Standard

Notes:

Standard: The model has this function, the customers can connect corresponding device through this port, such as water pump and hotel key card etc.

Customized: This function needs to be customized before leaving the factory.

Reserved: This port can not be used.

Figure 1.10: Wall-mounted Unit main PCB ports (Model 71/80/90)

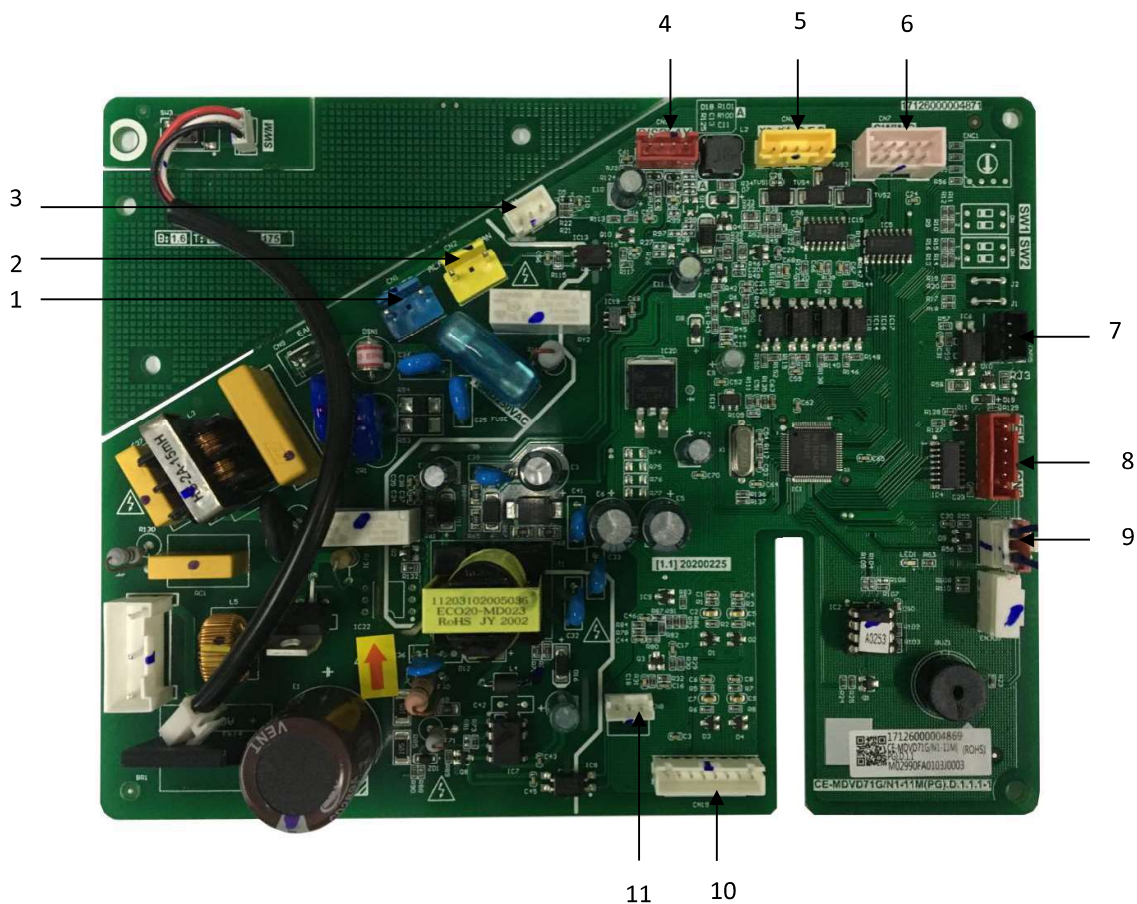

Table 1.10: Wall-mounted Unit main PCB ports (Model 71/80/90)

Label in Figure 1.10	Code	Content	Port voltage	Note
1	CN1	AC power input	220V AC	Standard
2	CN2	ALARM/Pump drive port	220V AC	Customized
3	CN3	Check key connection	5V DC	Standard
4	CN12	Display panel connection	5V DC	Standard
5	CN18	X1 X2 communication port	18V DC	Customized
		P Q E communication port	2.5-2.7V DC	Standard
6	CN13	Vertical louver	12V DC	Standard
7	CN55	Remote on/off switch connection	12V DC	Standard
8	CN6	EEV drive port	12V DC	Standard
9	CN5	Water level switch connection	5V DC	Standard
10	CN19	Red: Indoor heat exchanger outlet temperature sensor connection;	5V DC	Standard
		White: Indoor ambient temperature sensor connection;		
		Black: Indoor heat exchanger mid-point temperature sensor connection;		
11	CN8	PG FAN Back	12V DC	Standard
12	CN4	PG Fan connection	220V AC	Standard

Notes:

Standard: The model has this function, the customers can connect corresponding device through this port, such as water pump and hotel key card etc.

Customized: This function needs to be customized before leaving the factory.

Reserved: This port can not be used.

2 Indoor Unit Field Settings

2.1 PCB Switch and Jumper Settings

2.1.1 Four-way Cassette, Compact Four-way Cassette

Table 2.1: 0/1 definition of each dial code switch:











Switch	Meaning
	Means 0
	Means 1

Table 2.2: Four-way Cassette, Compact Four-way Cassette main PCB settings

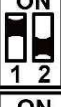
Switch	Setting	Switch positions ¹	Description
SW8(optional)	Alarm port		Alarm port is used to output alarm signal
			Alarm port is used as fresh air port
			Alarm port is used as running output of indoor units
			Alarm port is used to output alarm signal
SW9_1(optional)	Forced to shut down		Unit is forced to shut down when remote switch is ON
			Unit is forced to shut down when remote switch is OFF
SW9_2	/	/	(reserved)
J1	Auto restart ²		Auto restart function enabled
			Auto restart function disabled
J2	Network module and infrared function of display board		CN20 network module enabled(external network module is needed) and the infrared function of display board disabled
			CN20 network module disabled and the infrared function of display board enabled
ENC1	Indoor unit capacity ³		0: 1/1.2kW; 1: 1.5/1.7/1.8kW; 2: 2.2kW; 3: 2.5/2.8kW; 4: 3.2/3.6kW 5: 4.0kW; 6: 4.5kW; 7: 5.0/5.6kW; 8: 6.3/7.1kW;9: 8.0kW; A:8.5/9.0; B:10.0/10.4/10.6kW; C:11.2kW; D:12.0/12.5/12.8kW; E: 14kW

Notes:

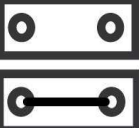
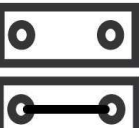
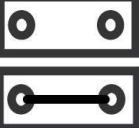
1. The black rectangles denote the switch positions.
2. Refer to 2.2.3 "Auto restart setting".
3. For Compact Four-way, ENC1 switch setting is from 1 to 6, for Four-way Cassette, ENC1 switch setting is from 3 to E.

2.1.2 Medium Static Pressure Duct, High Static Pressure Duct Unit, Ceiling & Floor, One-way Cassette, Two-way Cassette

Table 2.3: Medium Static Pressure Duct, High Static Pressure Duct Unit, Ceiling & Floor, One-way Cassette, Two-way Cassette main PCB settings















Switch	Setting	Switch positions ¹	Description
SW7_1 ²	/	/	Reserved
SW7_2	Indoor unit capacity		Unit with capacity less than 18kW
			Unit with capacity equals or more than 18kW
SW8(optional)	Alarm port		Alarm port is used to output alarm signal
			Alarm port is used as fresh air port
			Alarm port is used as running output of indoor units
			Alarm port is used to output alarm signal
SW9_1(optional)	Forced to shut down		Unit is forced to shut down when remote switch is ON
			Unit is forced to shut down when remote switch is OFF
SW9_2	/	/	(reserved)

Table 2.4: Medium Static Pressure Duct, High Static Pressure Duct Unit, Ceiling & Floor, One-way Cassette, Two-way Cassette main PCB settings (continued)





Switch	Setting	Switch positions ¹	Description
J1	Auto restart ²		Auto restart function enabled
			Auto restart function disabled
J2	Network module and infrared function of display board		CN20 network module enabled(external network module is needed) and the infrared function of display board disabled
			CN20 network module disabled and the infrared function of display board enabled
ENC1	Indoor unit capacity ³		0: 1/1.2kW; 1: 1.5/1.7/1.8kW; 2: 2.2kW; 3: 2.5/2.8kW; 4: 3.2/3.6kW 5: 4.0kW; 6: 4.5kW; 7: 5.0/5.6kW; 8: 6.3/7.1kW;9: 8.0kW; A:8.5/9.0; B:10.0/10.4/10.6kW; C:11.2kW; D:12.0/12.5/12.8kW; E: 14kW
ENC1+SW7_2	Indoor unit capacity ^{4,5}	ENC1 +  SW7	Toggle switch E: 14kW; F: 15/15.8/16kW
ENC1+SW7_2	Indoor unit capacity	ENC1 +  SW7	0: 18kW; 1: 20kW; 2: 22.4/25/25.2kW; 3: 28kW; 4: 33.5kW 5:40kW; 6:45kW; 7:50kW/56kW/58kW

Notes:

1. The black rectangles denote the switch positions.
2. Refer to 2.2.3 "Auto restart setting".
3. For Medium Static Pressure Duct, Ceiling & Floor, One-way Cassette, Two-way Cassette and High Static Pressure Duct(Model 71/80/90/112),setting the capacity only use ENC1 toggle switch.
4. SW7 only exist in PCB of High Static Pressure Duct(Model 140/160/200/250/280/400/450/560)
5. For High Static Pressure Duct(Model 140/160/200/250/280/400/450/560),setting the capacity need to use both ENC1 and SW7_2.

2.1.3 Wall Mounted

Table 2.5: Wall Mounted main PCB settings

Switch	Setting	Switch positions ¹	Description
J1(optional)	Auto restart ²		Auto restart function enabled
			Auto restart function disabled
J2(optional)	Pump and Alarm signal output		CN2 port: Pump signal output
			CN2 port: Alarm signal output
ENC1	Indoor unit capacity		0: 1/1.2kW; 1: 1.5/1.7/1.8kW; 2: 2.2kW; 3: 2.5/2.8kW; 4: 3.2/3.6kW 5: 4.0kW; 6: 4.5kW; 7: 5.0/5.6kW; 8: 6.3/7.1kW; 9: 8.0kW; A: 8.5/9.0; B: 10.0/10.4/10.6kW; C: 11.2kW; D: 12.0/12.5/12.8kW; E: 14kW

Notes:

1. The black rectangles denote the switch positions.
2. Refer to 2.2.3 "Auto restart setting".

2.2 Modes Set on Main PCBs

2.2.1 Auto restart setting







The auto restart function can be used to ensure that, in the event of a power outage, the indoor units automatically restart once the power returns. When the power returns following a power outage, units with auto restart enabled restart with the same operating mode, fan speed and remote control lock status settings as before the power outage. The restart of indoor units is staggered, with the start-up of some units delayed to prevent all units starting-up simultaneously. If, during this timed delay, the remote or wired controller is used to send a command to a unit, that unit starts-up immediately with those new settings. Indoor units with auto restart disabled go into standby once the power returns following a power outage.

3 Display Panels

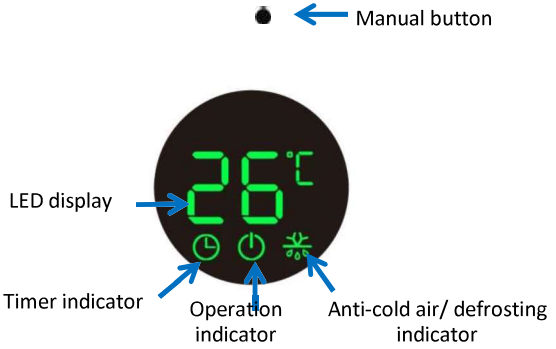
3.1 Appearance of Display Panel

The appearance of the digital display panel used is shown in Figures 3.1.

Figure 3.1: Digital display panel¹

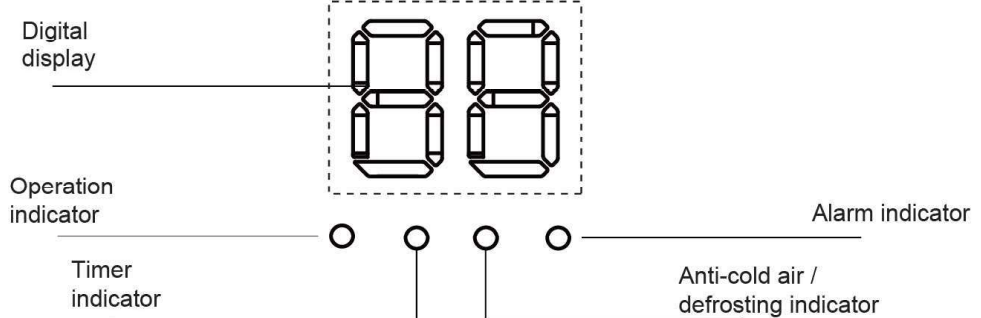

<p>Display panel for four-way cassette (New 360 degree panel, standard panel)</p>	<p>Display panel for four-way cassette (Optional)</p>
	
<p>Display panel for compact four-way cassette</p>	<p>Display panel for one-way cassette</p>
	
<p>Display panel for ceiling and floor</p>	<p>Display panel for two-way cassette, medium static pressure duct and high static pressure duct</p>
	
<p>Display panel for Wall Mounted²</p>	
	

Notes:

1. The pictures are just for reference, the exact appearance of digital panel maybe slightly different.
2. For Wall Mounted, the digital display needs to be customized.

3.2 Output under Normal Operating Conditions

Table 3.1: Display panel output under normal operating conditions

Unit state		Display output	
		Lights/Icons	Digital display
Standby		Operation indicator flashes slowly	
Shutting-down		All indicators off?	
Operating	Normal operation	Operation indicator on	Cooling and heating modes: set temperature Fan only mode: indoor ambient temperature
	Cold draft prevention or outdoor unit defrosting operation	Operation and Anti-cold / defrosting indicators on	Set temperature
A timer has been set		Timer indicator on	n/a

Notes:

1. The display panel should be installed in the ceiling, nothing can be exposed but the panel face.

3.3 Digital Display Parameter Output

On pressing the manual button^{1,2} on a digital display panel the parameters given in Table 3.1 are displayed (unless the unit is in an error state, in which case the digital display displays the error code). On the first press, parameter no. 1 is displayed, on the second press, parameter no. 2 is displayed, and so on. If the button is not pressed for 10 seconds, the display returns to its normal display, as described in Table 3.1.

Notes:

1. The manual buttons refer to 3.1 "Appearance of Display Panel".
2. For the four-way cassette's new 360 degree panel, a needle is necessary to active manual button.

3.3.1 Spot check table

Table 3.1: Digital display output when button on a digital display panel is pressed

Parameter no.	Parameters	Remarks
0	Normal display	
1	Communication address ¹	0 - 63
2	Capacity as set on ENC1 switch on indoor unit main PCB	Unit: HP
3	Network address ¹	0 - 63
4	Set temperature Ts	
5	T1 indoor temperature	Minimum value -9°C
6	T2 indoor heat exchanger mid-point temperature	Minimum value -9°C
7	T2A Indoor heat exchanger inlet temperature	Minimum value -9°C
8	T2B Indoor heat exchanger outlet temperature	Minimum value -9°C
9	Compressor discharge temperature	
10	Target superheat (reserved)	
11	EXV steps (actual steps / 8)	
12	Version number of indoor unit's main program software	
13	Swing small board software version number	Only available for Q4 360 degree panel and A5 duct intelligent panel. Apart from above conditions, it shows "0".
14	Error code 1 (last time)	
15	Error code 2 (last but one)	
16	Error code 3 (last but two)	
17	Number of times the IDU address was set using ODU Auto Addressing Switch (Record 99 times at most)	
18	Number of times the IDU address was set using remote controller (99 times at most)	
19	Number of times the IDU address was set using wired controller (99 times at most)	
20	--	

Notes:

1. For indoor units, the communication address and network address are the same and are routinely referred to simply as the unit's "address".

4 Control

4.1 EXV Control

When the IDU is powered on again or the ODU is stopped, the system automatically enters initialization mode. After initialization is completed, the system enters the normal start mode. The IDU EXV uses superheat degree control in cooling mode and uses supercool degree control in heating mode. If the IDU receives a protection control or special control command, this command is executed in priority.

- **Superheat Degree Control in Cooling Mode**

During cooling (dry), the IDU calculates the difference of the indoor evaporator outlet temperature (T_{2B}) received and the average value ($\overline{T_{2B}}$) of the evaporator outlet temperature detected by the IDU and sent by the ODU based on the following formula and uses the difference as the current superheat degree (SH). By comparison of the current superheat degree (SH) with the set superheat degree (SHS), the opening adjustment trend of the EXV can be decided.

$$T_{2B} - \overline{T_{2B}} = SH$$

- ◆ When $SH > SHS$, the EXV opening increases
- ◆ When $SH = SHS$, the EXV opening unchanged
- ◆ When $SH < SHS$, the EXV opening decreases

- **Supercool Degree Control in Heating Mode**

During heating, the IDU calculates the difference of the indoor evaporator middle temperature (T_2) received and the average value ($\overline{T_2}$) of the evaporator middle temperature detected by the IDU and sent by the ODU based on the following formula, and uses the difference as the current supercool degree (SC). By comparing the current supercool degree (SC) with the set supercool degree (SCS), the opening adjustment trend of the EXV can be determined.

$$T_2 - \overline{T_2} = SC$$

- ◆ When $SC > SCS$, the EXV opening increases
- ◆ When $SC = SCS$, the EXV opening unchanged
- ◆ When $SC < SCS$, the EXV opening decreases

- **EXV Operating in Different Situations**

The EXV decides its operating opening based on the IDU operating mode, IDU working mode, and ODU working mode. For details, see the following table:

IDU Status	Cooling Mode		Heating Mode	
	ODU Operating	ODU Stopped	ODU Operating	ODU Stopped
Operating	Superheat control		Supercool control	
Standby	0 PLS		300 PLS	
Off				
Fault				

Note:

PLS indicates the unit of pulses regarding the EXV opening.

4.2 Start and Stop Control

After receiving the operating requirements from the remote controller, wired controller, or centralized controller, the IDU determines the operating status based on the difference of the detected return air temperature (T_1) and the user set temperature (T_s). Due to imbalanced distribution of indoor heat, solar radiation, the rising of hot air, and other factors, the

return air temperature detected by the return air temperature sensor (T_1) of the IDU differs from the temperature in the area where users are active. This will cause the air temperature of the activity area to differ from the user set temperature when the IDU reaches the set temperature and enters standby mode. There are two solutions to this problem:

1. Enable Follow Me. The IDU will use the temperature detected by the indoor temperature sensor of the controller as the return air temperature to determine whether the machine operates or remains in standby mode.
2. Enable temperature compensation to add the temperature compensation value ΔTC to $(T_1 - T_s)$. This revises the difference of the return air temperature and that of the activity area caused by the preceding factors.

● Cooling (Dry)

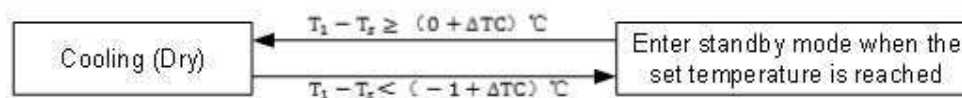

● Heating

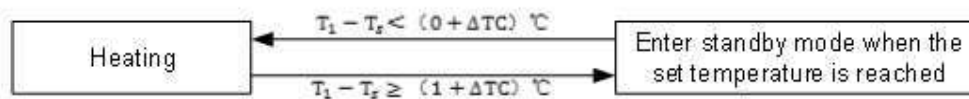

Note:

For the temperature compensation value ΔTC in cooling or heating mode, see the user manual of different machine types. For details, consult the local technical support engineers.

4.3 Fan Control

The IDU can work in seven-speeds (strong, super-high, high, middle, low, breeze, and sleep) or three-speed mode. For details about specific modes, see the technical manual of corresponding unit type.

● **Fan Control in Different Situations**

Operating in Set Speed	IDU Status	Cooling Mode	Dry Mode	Heating Mode	Fan Mode	Speed Switch
	Operating	Set speed	Low	Set speed	Set speed	User set
	Standby	Set speed	Low	Specified mode	/	
	Off	Stop fan	Stop fan	Stop fan	Stop fan	
	Fault	Stop fan	Stop fan	Stop fan	Stop fan	
Automatic Fan Speed	IDU Status	Cooling Mode	Heating Mode	Auto	Fan Mode	Speed Switch
	Operating	Automatic	Automatic	Automatic	Low	Switch fan speed based on the difference of the set temperature and return air temperature
	Standby	Automatic	Specified mode	Automatic cooling, automatic fan speed, automatic heating, and specified mode operating	/	
	Off	Stop fan	Stop fan	Stop fan	Stop fan	
	Fault	Stop fan	Stop fan	Stop fan	Stop fan	

Note:

When the IDU fan changes from specified mode to heating and standby mode, it will stop for a period of time. The length of this period can be set. After this period, the fan will operate in low mode for one minute.

● **Air Guide Louver Swing Control**

- 1) Swing angle is controlled through the stepper motor. It has five levels. After the swing angle is set, the IDU automatically records the swing angle and jumps to this initial angle by default each time the machine is started. The swing angle can be set to different values based on the IDU type.
- 2) After a start signal is received, if the air guide louver has been zeroed, it will open immediately. If the air guide louver is being zeroed, it will open again after zeroing. The fan start is delayed.
- 3) After the stop signal is received, the air guide louver is closed to the minimum angle P0, and this position is kept 60 seconds after the fan is stopped, the air guide louver is closed. If the IDU encounters anti-cold air during heating, the fan turns off immediately. The air guide louver will remain at its current angle.

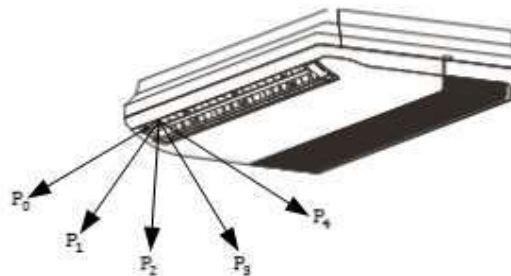

● **Anti-cold Air Control**

This function may only be used in heating mode. Fan speed is changed according to the middle temperature (T_2) of the evaporator. While in anti-cold air mode, if the indoor fan is off, the preheat/defrost indicator is on; once the indoor fan is off, the preheat/defrost indicator turns off. When the IDU is in heating mode, the anti-cold air control is valid during the oil return or defrosting period. If the IDU is turned off, the fan is turned off as well.

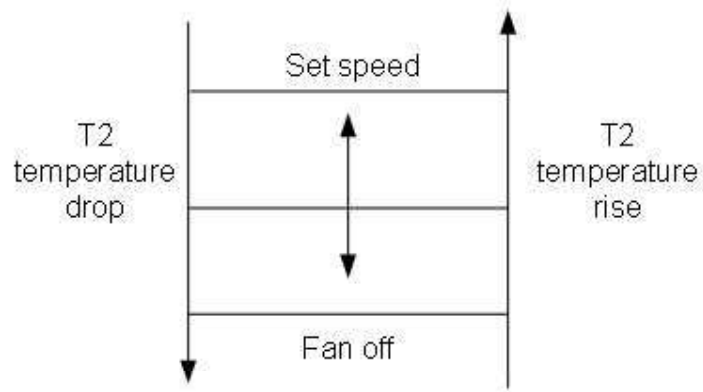

Note:

When the fan is turned off, the middle temperature (T_2) of the evaporator can be set through the DIP or controller.

4.4 Auto Mode

Upon receiving an auto mode signal, the IDU determines a mode based on logic. If the determined mode is consistent with the ODU mode, the IDU operates in the ODU mode. If the determined mode is different from the ODU mode, the IDU controls based on the mode conflict control logic. During the initial power-on, the temperature is set as follows in auto

mode: temperature in heating $T_{sh} = 21^\circ\text{C}$, temperature in cooling $T_{sc} = 24^\circ\text{C}$. The cooling temperature is set prior to the heating temperature. $D2 = \text{Cooling temperature} - \text{Heating temperature} \geq 0^\circ\text{C}$. D1 and D3 indicate the on and off return difference in cooling mode and the on and off return difference in heating mode, respectively.

- **Switching Modes**

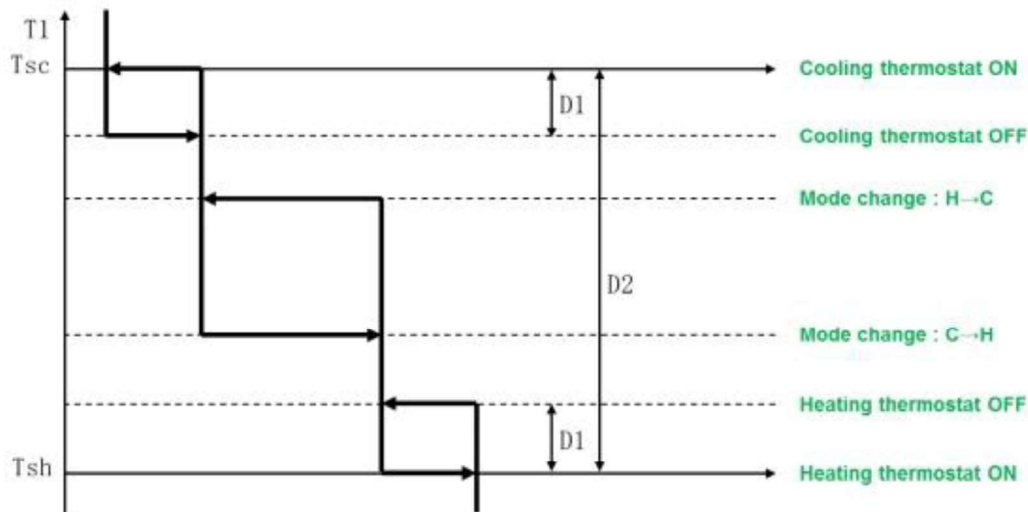

● **Set Temperature Display**

- 1) When switching between cooling, heating or auto modes, if temperature Ts is not reset, the temperature after switching is the same as the temperature before switching.
- 2) In auto mode, switching between cooling and heating mode takes some time. The time can be set through the controller.

4.5 Mode Conflict

If the IDU start mode differs from the ODU start mode, a mode conflict failure is reported by the IDU. The following table lists failures reported in different IDU and ODU statuses.

ODU Type		ODU Status		
IDU Type	IDU Status	Off	Cooling	Heating
Conventional IDU	Cooling	No	No	Yes
	Dry	No	No	Yes
	Heating	No	Yes	No
	Fan	No	No	Yes
V6 DC FAPU	Cooling	No	No	Yes
	Heating	No	Yes	No
	Fan	No	No	No

Note:

FACU stands for Fresh Air Processing Unit.

4.6 Controlling the Condensate Water Pump and Water Level Switch

- 1) When the IDU is powered on the first time, the water pump is forced to operate for five minutes.
- 2) When the IDU and ODU are in cooling mode, the water pump starts immediately and operates continuously. After this mode is stopped (stop and mode switch), the water pump turns off five minutes later.
- 3) If the water level rises, causing the water level switch to be disconnected, the condensate water pump immediately starts and operates. Five minutes later, if the water level drops to lower than the alarm level, the system restores operation based on the originally set mode. Otherwise, the IDU and water pump stop operating, and a water level alarm is reported. When the water level switch is connected again, the protection is released, and the system restores operation based on the mode that was originally set.

Note:

This function is reserved for the unit models without drainage pumps and water level switches and it is disabled by default.

4.7 Anti-freeze Control

During cooling or drying, if the detected indoor evaporator outlet temperature (T_{2B}) or indoor evaporator middle temperature (T_2) drops too low, the machine enters anti-freeze control based on the following conditions. When anti-freeze protection is triggered, the IDU will not display an error code, the EXV is closed, the compressor output is dropped, the drainage pump operates continuously, and the fan operates based on the set speed. When the indoor evaporator outlet temperature (T_{2B}) or indoor evaporator middle temperature (T_2) rises to a specific threshold, anti-freeze protection shuts off.

4.8 Display Function

- 1) In standby mode, the operating indicator continues flashing slowly, and "--" appears on both digital displays.
- 2) While the unit is stopped, the operating indicator is off, and "--" appears on both digital displays.
- 3) While the unit is operating, the operating indicator is on, and two digital displays are on. In cooling or heating mode, the digital display shows the set temperature. In fan mode, the digital display shows the indoor temperature.
- 4) When anti-cold air is on, if the indoor fan is off, the preheat/defrost indicator is on; when the indoor fan is on, the preheat/defrost indicator is off.
- 5) When defrost is on, the preheat/defrost indicator is on. After defrosting ends, the preheat/defrost status is

determined based on the anti-cold air protection. If the IDU is equipped with a VR heat recovery ODU, the defrost indicator is not displayed when the defrost signal is changed to ON.

- 6) The timer indicator is not on when the light button is set to off.
- 7) When the IDU receives a non-inquiry command from the remote controller or wired controller, the operating indicator and digital display are on.
- 8) When the IDU receives the address inquiry command from the remote controller or wired controller, the indicator is off, and the digital display is on and shows the address. The indicator will turn on after 10s and the digital display shows the operating status.
- 9) When the IDU receives any command from the centralized controller, the digital display or indicator on the display board will be on.
- 10) In the fault status, the digital display is on, and the error code is displayed (see the error code list for details). After the fault is cleared, the IDU operates and can be controlled normally.

5 Errors

5.1 Error Code Table

Table 5.1: Error code table

Error code	Content
E0	Mode conflict
E1	Communication error between indoor and outdoor units
E2	Indoor ambient temperature sensor error
E3	Indoor heat exchanger mid-point temperature sensor error
E4	Indoor heat exchanger outlet temperature sensor error
E6	Fan error
E7	EEPROM mismatch
E9	Communication error with wired controller
Eb	Electronic expansion valve error
Ed	Outdoor unit error
EE	Water level error
FE	Indoor unit has not been assigned an address
H4	Communication error between main board and display board
H5	EEPROM of display board damaged
A1	Refrigerant leakage fault
A0	The emergency stop
F7+ repeated address	Repeated indoor units address
U4	MS box self-check failure
F8	MS box Error
FA	Capacity(HP) has not been set

Table 5.2: Error code table of Wall Mounted

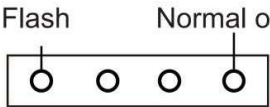
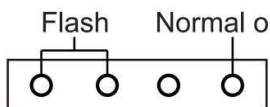
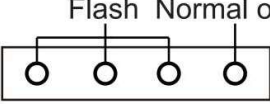
Phenomenon	Flash Times	Error code	Content
	1	E0	Mode conflict
	2	E1	Communication error between indoor and outdoor units
	3	E2	Indoor ambient temperature sensor error
	4	E3	Indoor heat exchanger mid-point temperature sensor error
	5	E4	Indoor heat exchanger outlet temperature sensor error
	6	E6	Fan error
	7	E7	EEPROM mismatch
	8	/	/
	1	Eb	Electronic expansion valve error
	2	Ed	Outdoor unit error
	3	EE	Water level error
	4	A0	The emergency stop
	5	A1	Refrigerant leakage fault
	6	FE	Indoor unit has not been assigned an address
	7	FA	Capacity(HP) has not been set
	8	H4	Communication error between indoor unit and panel
	1	U4	MS box self-check failure
	2	F8	MS box Error
	3	F7+ repeated address	Repeated indoor units address

5.2 Impact on Other Units

Table 5.3 shows the impact of an error on one indoor unit on the outdoor units and on the other indoor units in the system. The actual state of the outdoor units and the other indoor units is determined not only by the impacts shown in Table 4.3, but also by any other errors that may have separately arisen on the outdoor units or other indoor units.

Table 4.3: Impact of indoor unit error on outdoor units and on other indoor units

Indoor unit error	Impact on outdoor units	Impact on other indoor units
E0	Minimal impact ¹	No impact
E1	H7 error ²	Ed error ³
E2	Minimal impact ⁴	No impact
E3	Minimal impact ⁴	No impact
E4	Minimal impact ⁴	No impact
E6	Minimal impact ⁴	No impact
E7	Minimal impact ⁴	No impact
E9	No impact	No impact
Eb	Minimal impact ⁴	No impact
Ed	n/a ⁵	n/a ⁵
EE	Minimal impact ⁴	No impact
FE	H7 error ²	Ed error ³
H5	Minimal impact ⁴	No impact
H4	Minimal impact ⁴	No impact
A1 ⁶	No impact	Ed error ³
A0 ⁶	No impact	Ed error ³
F7+ repeated address ⁵	No impact	No impact
U4 ⁶	No impact	No impact
F8 ⁶	No impact	Ed error ³
FA	No impact	No impact
H4	Minimal impact ⁴	No impact

Notes:

1. The outdoor units continue to operate and ignore the load requirement from the indoor unit that has gone into mode conflict with the outdoor units.
2. Outdoor unit error code H7 indicates that the number of indoor units detected by the master outdoor unit is not the same as the number set on the master outdoor unit's main PCB.
3. Error Ed may not be displayed on the other indoor units. Indoor unit error codes have the following order of priority: A1-A0-FE-F7-E0-E1-E2-E3-E4-E6-E7-Eb-Ed-EE-H4-U4-F8. So if, for example, one unit has an E2 error, it continues to display E2 even if an E1 or FE error occurs on another indoor unit (giving rise to an outdoor unit H7 error) since error Ed is lower in the order of priority than error E2.
4. The outdoor units continue to operate but detect no load requirement from the indoor unit that has experienced an E2, E3, E4, E6, E7, Eb or EE error, and adjust their output accordingly, in the same way as they do when a user puts an indoor unit into standby.
5. An indoor unit Ed error is caused by (and not the cause of) an outdoor unit error. The outdoor units will be displaying their own error code.
6. Only applicable for V6R system.

6 Troubleshooting

6.1 Warning

Warning



- All electrical work must be carried out by competent and suitably qualified, certified and accredited professionals and in accordance with all applicable legislation (all national, local and other laws, standards, codes, rules, regulations and other legislation that apply in a given situation).
- Power-off the unit before connecting or disconnecting any connections or wiring, otherwise electric shock (which can cause physical injury or death) may occur or damage to components may occur.

6.2 E0 Troubleshooting

6.2.1 Display output



6.2.2 Description

- Mode conflict.

6.2.3 Impact on other units

- Refer to [5.2 “Impact on Other Units”](#).

6.2.4 Possible causes

- The indoor unit's operating mode conflicts with that of the outdoor units.

6.2.5 Explanation

There are five priority mode options, which are set on the outdoor units. If an indoor unit's operating mode conflicts with that of the outdoor units, the indoor unit displays the mode conflict error. The five priority modes are:

1. **Heating priority mode (default):**

- a) **During cooling operation:** If an indoor unit requests heating, the outdoor units stop and then restart in heating mode after 5 minutes. Indoor units requesting heating then start in heating mode and indoor units requesting cooling display the mode conflict error.
- b) **During heating operation:** If an indoor unit requests cooling, the outdoor units ignore the request and continue to run in heating mode. The indoor unit requesting cooling displays the mode conflict error. If all the indoor units requesting heating are later turned off and one or more indoor units are still requesting cooling, the outdoor units restart in cooling mode after 5 minutes and any indoor units requesting cooling then start in cooling mode.

2. **Cooling priority mode:**

- a) **During heating operation:** If an indoor unit requests cooling, the outdoor units stop and then restart in cooling mode after 5 minutes. Indoor units requesting cooling then start in cooling mode and indoor units requesting heating display the mode conflict error.
- b) **During cooling operation:** If an indoor unit requests heating, the outdoor units ignore the request and continue to run in cooling mode. The indoor unit requesting heating displays the mode conflict error. If all the indoor units requesting cooling are later turned off and one or more indoor units are still requesting heating, the outdoor units restart in heating mode after 5 minutes and any indoor units requesting heating then start in heating mode.

3. **VIP priority mode or voting priority mode:** 63 is the VIP address. If the VIP indoor unit is operating, the outdoor units operate in the mode of the VIP indoor unit. Indoor units that are in a mode different to that of the VIP unit display the mode conflict error. If there is no unit with address 63 or the unit at address 63 is in standby, the outdoor units operate in voting priority mode. In voting priority mode, the outdoor units operate in whichever of heating and cooling modes is being requested by the larger number of indoor units.

4. **Heating only mode:** The outdoor units only operate in heating mode. Indoor units requesting heating operate in heating mode. Indoor units requesting cooling or in fan only mode display the mode conflict error.

5. **Cooling only mode:** The outdoor units only operate in cooling mode. Indoor units requesting cooling operate in cooling mode; indoor units in fan only mode operate in fan only mode. Indoor units requesting heating display the mode conflict error.

6.3 E1 Troubleshooting

6.3.1 Display output



6.3.2 Description

- Communication error between indoor and outdoor units.

6.3.3 Impact on other units

- Refer to [5.2 "Impact on Other Units"](#).

6.3.4 Possible causes

- Communication wires between indoor and outdoor units not connected properly.
- Interference from high voltage wires or other sources of electromagnetic radiation.
- Communication wire too long.
- Damaged main PCB.

6.3.5 Procedure

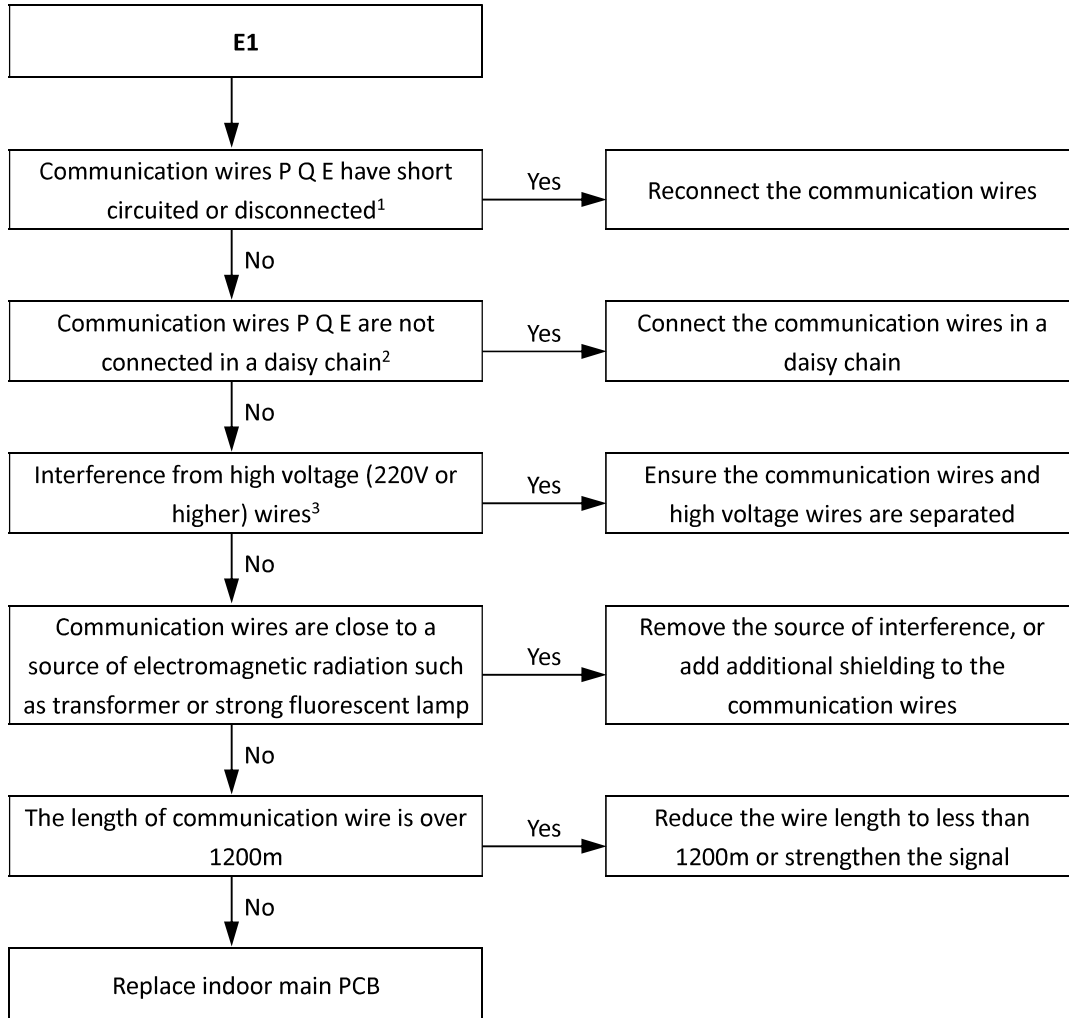

Notes:

1. Measure the resistance among P, Q and E. The normal resistance between P and Q is 120Ω, between P and E is infinite, between Q and E is infinite.
2. The P Q E communication wires should be connected one unit after another in a daisy chain from the master outdoor unit to the final indoor unit. After the final indoor unit, the communication wiring should NOT be continued back to the outdoor units – that is, do not attempt to form a closed loop.
3. The refrigerant piping, power wiring and communication wiring are typically run in parallel. However the communication wiring should not be bound together with the refrigerant piping or power wiring. To prevent signal interference, the power wiring and communication wiring should not be run in the same conduit. If the power supply is less than 10A, a separation of at least 300mm between power wiring and communication wiring conduits should be maintained; if the power supply is in the range 10A to 50A then a separation of at least 500mm should be maintained.

6.4 E2, E3, E4 Troubleshooting

6.4.1 Display output



6.4.2 Description

- E2 indicates an indoor ambient temperature sensor error.
- E3 indicates an indoor heat exchanger mid-point temperature sensor error.
- E4 indicates an indoor heat exchanger outlet temperature sensor error.

6.4.3 Impact on other units

- Refer to 5.2 “Impact on Other Units”.

6.4.4 Possible causes

- Temperature sensor not connected properly or has malfunctioned.
- Damaged main PCB.

6.4.5 Procedure

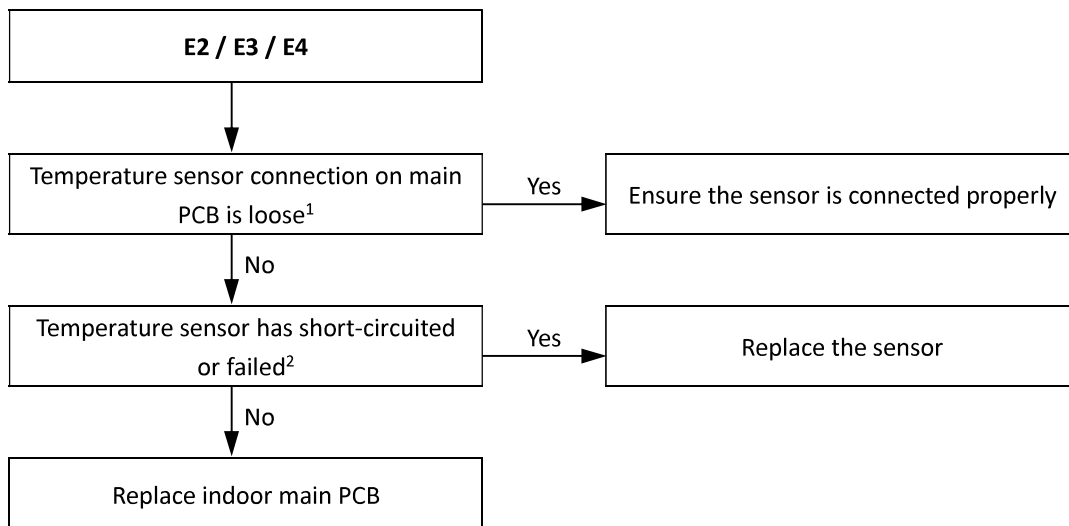

Notes:

1. The indoor ambient temperature sensor connection port, indoor heat exchanger mid-point temperature sensor connection port and indoor heat exchanger outlet temperature sensor connection port on each type of indoor unit main PCB are labeled in Figures 1.1 to 1.19 in 1, “Main PCB Ports”.
2. Measure sensor resistance. If the resistance is too low, the sensor has short-circuited. If the resistance is not consistent with the sensor’s resistance characteristics table, the sensor has failed. Refer to Table 6.1 in 6.1 “Temperature Sensor Resistance Characteristics”.

6.5 E6 Troubleshooting Display output

6.5.1 Display output



6.5.2 Description

- Fan error.
- Either the main PCB cannot detect the fan, or the difference between the actual fan speed and the target fan speed exceeds the limit.

6.5.3 Impact on other units

- Refer to [5.2 “Impact on Other Units”](#).

6.5.4 Possible causes

- Fan stuck or blocked.
- Fan motor not connected properly or has malfunctioned.
- Power supply abnormal.
- Damaged main PCB.

6.5.5 Procedure

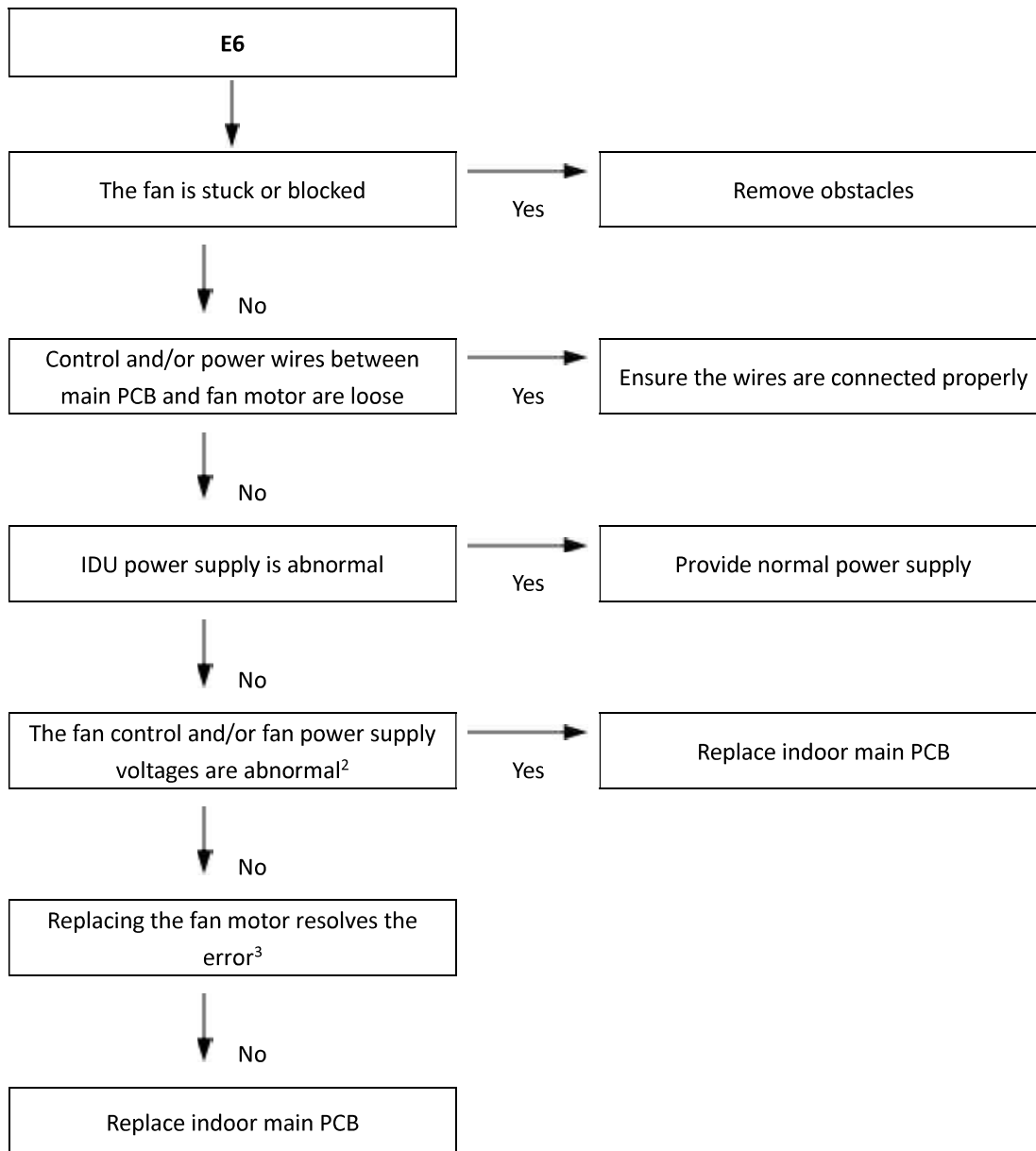

Notes:

1. The fan connection on Wall Mounted main PCB is labeled in Figures 1.6 to 1.8 in [1, "Main PCB Ports"](#).
2. Measure the voltage between the red and black wires and between the white and black wires at the fan connection on the indoor unit main PCB. The normal voltage between the red and black wires is 310V (DC); the normal voltage between the white and black wires is 15V (DC). The fan connection on each type of indoor unit main PCB is labeled in Figures 1.6 to 1.8 in [1, "Main PCB Ports"](#). Refer also to Figure 5.1.
3. Remove the fan motor and install a new one. Power-on the unit, set it to run with fan speed set to low, and see if the unit runs normally or not.

Figure 5.1: Fan connection wiring on indoor unit main PCBs

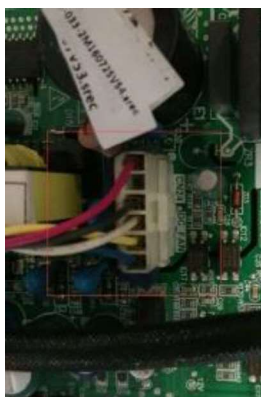

6.6 E7 Troubleshooting

6.6.1 Display output



6.6.2 Description

- EEPROM mismatch.

6.6.3 Impact on other units

- Refer to [5.2 "Impact on Other Units"](#).

6.6.4 Possible causes

- Damaged main PCB.

6.6.5 Procedure

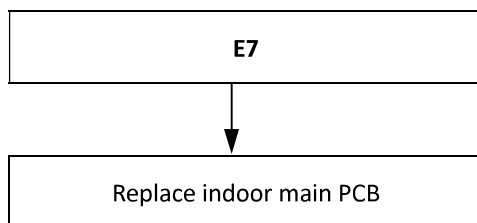

6.7 E9 Troubleshooting

6.7.1 Display output



6.7.2 Description

- Communication error with wired controller.

6.7.3 Impact on other units

- Refer to 5.2 “Impact on Other Units”.

6.7.4 Possible causes

- Abnormal power supply to the wired controller
- Wired controller is damaged
- The communication wire is disconnected, short circuit or loose
- Communication wire is too long (maximum length can be 200m only)
- Main PCB of IDU is damaged

6.7.5 Procedure

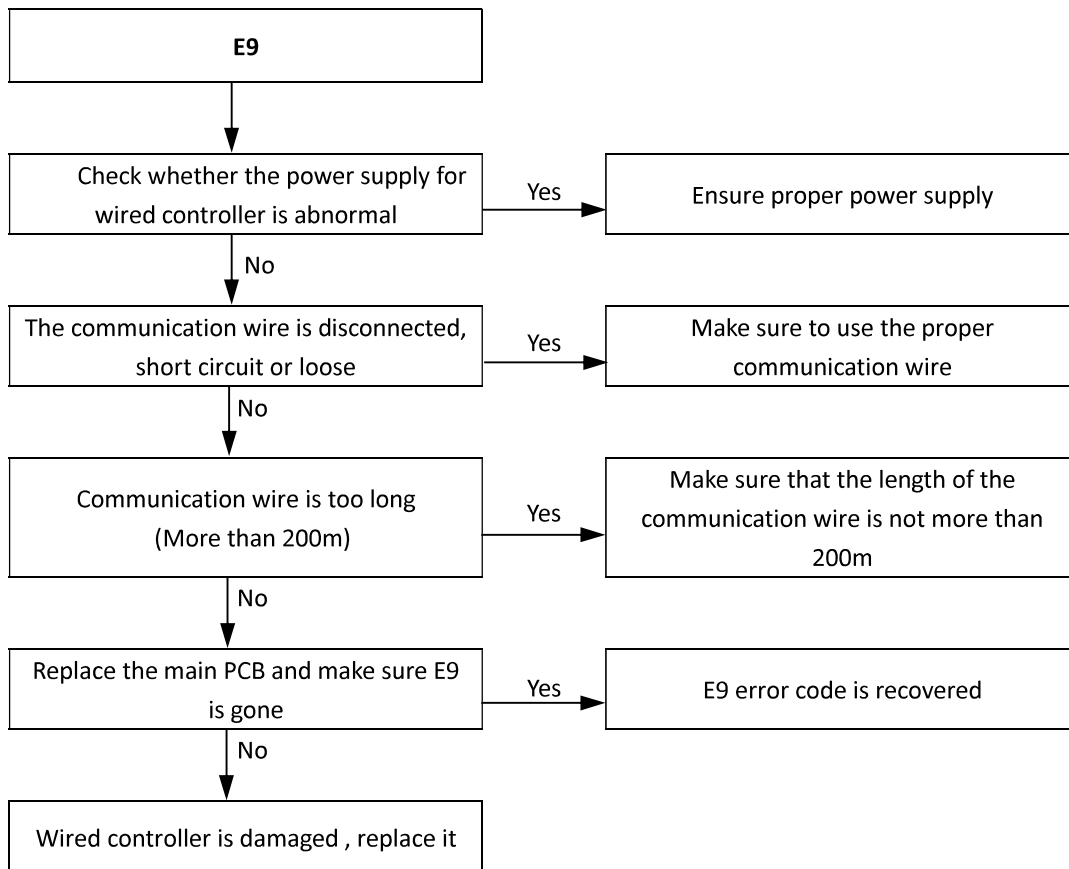

6.8 Eb Troubleshooting

6.8.1 Display output



6.8.2 Description

- Electronic expansion valve error.

6.8.3 Impact on other units

- Refer to 5.2 “Impact on Other Units”.

6.8.4 Possible causes

- Electronic expansion valve coil not connected properly or has malfunctioned.
- Damaged main PCB.

6.8.5 Procedure

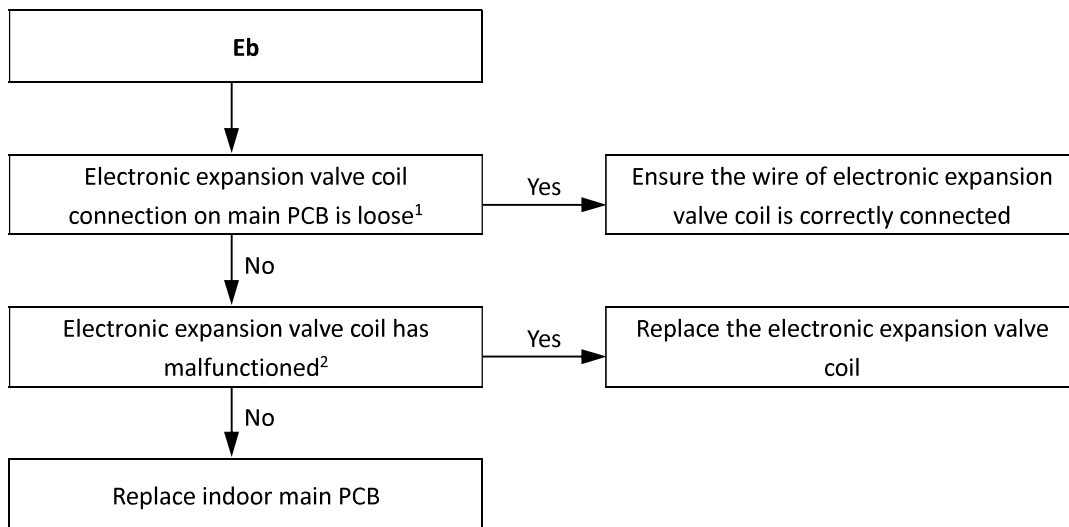

Notes:

1. The electronic expansion valve connection port on each type of indoor unit main PCB is labeled in Figures 1.1 to 1.19 in 1, “Main PCB Ports”.
2. The normal resistances between EXV coil wiring terminals RED and white / yellow / orange / blue are 40-50Ω. If any of the resistances is 0 or infinity, the EXV coil has malfunctioned.

Figure 5.2: EXV coil wiring terminals

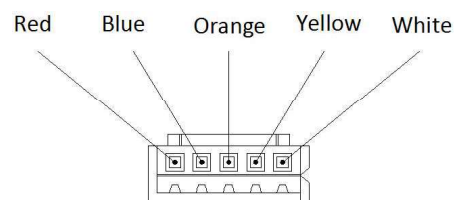

6.9 Ed Troubleshooting

6.9.1 Display output



6.9.2 Description

- Outdoor unit error.

6.9.3 Impact on other units

- Refer to [5.2 "Impact on Other Units"](#).

6.9.4 Possible causes

- Outdoor unit error.

6.9.5 Procedure

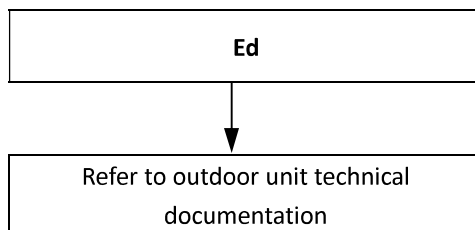

6.10 EE Troubleshooting

6.10.1 Display output



6.10.2 Description

- Water level error.

6.10.3 Impact on other units

- Refer to 5.2 “Impact on Other Units”.

6.10.4 Possible causes

- Water level float stuck.
- Water level switch not connected properly.
- Damaged main PCB.
- Drain pump has malfunctioned.

6.10.5 Procedure

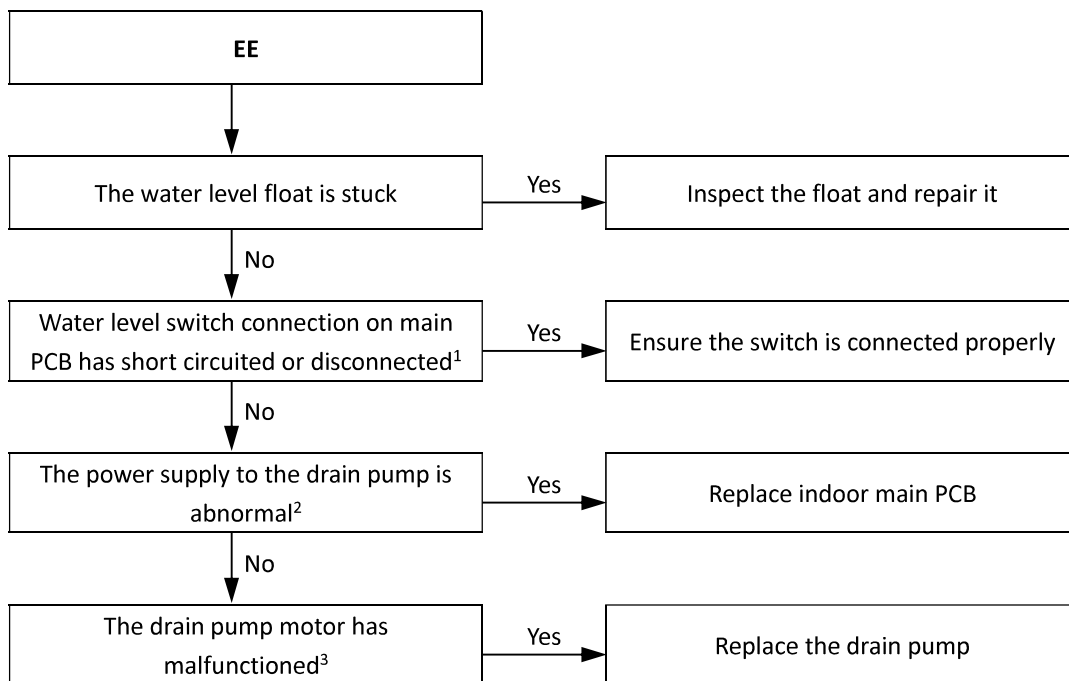

Notes:

- The water level switch connection port on each type of indoor unit main PCB is labeled in Figures 1.1 to 1.19 in 1, “Main PCB Ports”.
- Measure the voltage between the two pins of the drain pump connection on the indoor unit main PCB. The normal voltage range is 220 to 240 V (AC). The drain pump connection port on each type of indoor unit main PCB is labeled in Figures 1.1 to 1.19 in 1, “Main PCB Ports”.
- Measure the resistance between the two power supply terminals on the drain pump motor. If the resistance is either zero or infinite, the motor has malfunctioned.

6.11 FE Troubleshooting

6.11.1 Display output



6.11.2 Description

- Indoor unit has not been assigned an address.

6.11.3 Impact on other units

- Refer to [5.2 "Impact on Other Units"](#).

6.11.4 Possible causes

- Indoor unit has not been assigned an address.

6.11.5 Procedure

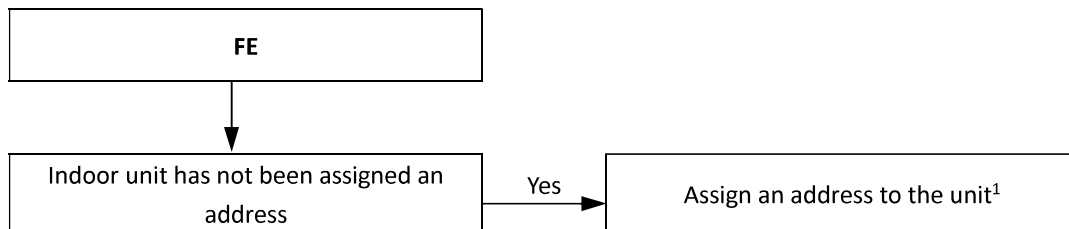

Notes:

- Indoor unit addresses can be manually assigned using indoor unit remote/wired controllers. Alternatively, indoor unit addresses can be automatically assigned by the master outdoor unit. Refer to the outdoor unit technical documentation. Note: Each unit in a system should be assigned a unique address - unit addresses should not be repeated within one system.

6.12 H4 Troubleshooting

6.12.1 Display output



6.12.2 Description

- Communication error between IDU main board and display board.

6.12.3 Impact on other units

- Refer to [3.2 "Impact on Other Units"](#).

6.12.4 Possible causes

- Communication wire between IDU main board and display board not connected properly.
- Panel is not compatible with the indoor unit.

6.12.5 Procedure

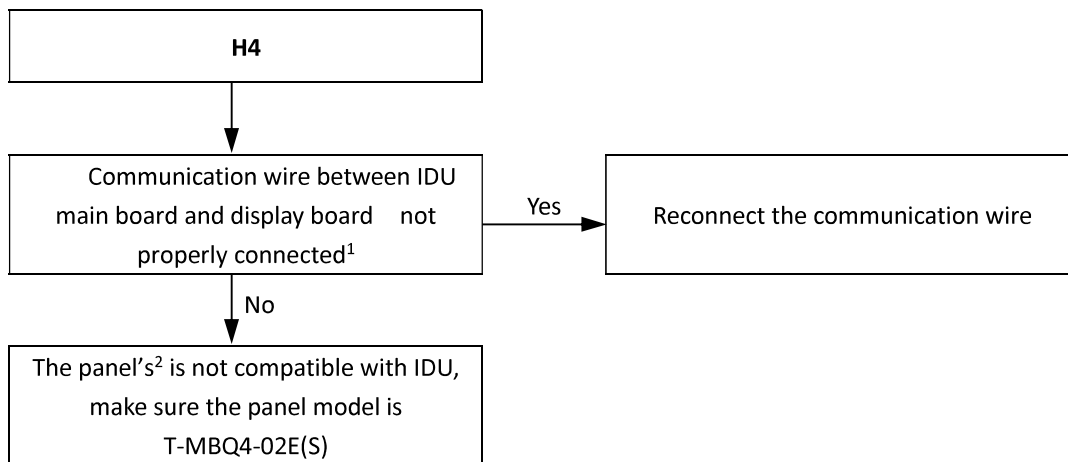

Notes:

1. The display board connection is port CN30 on the IDU main PCB (labeled 16 in Figure 1 in part 1 "Main PCB Ports").
2. Panel T-MBQ4-02E(S) is compatible with 16kW four-way cassette IDU.

6.13 H5 Troubleshooting

6.13.1 Display output



6.13.2 Description

- EEPROM of display board damaged.

6.13.3 Impact on other units

- Refer to [4.2 "Impact on Other Units"](#).

6.13.4 Possible causes

- EEPROM of display board damaged.

6.13.5 Procedure

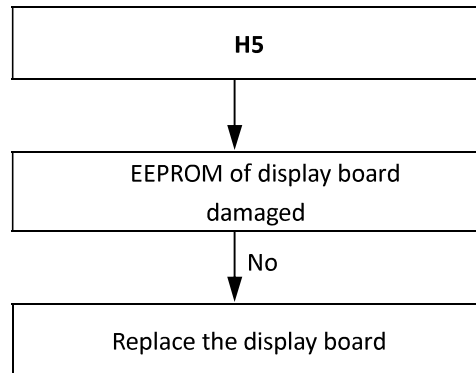

Notes:

1. The display board connection is port CN30 on the IDU main PCB (labeled 16 in Figure 1-1.1 in 1 "Main PCB Ports").

6.14 Louver Swing Failure Troubleshooting

6.14.1 Display output

- No special display output or error code.

6.14.2 Description

- Louvers fail to respond to instruction from wired or remote controller.

6.14.3 Possible causes

- Louver swing motor not connected properly or has malfunctioned.
- Damaged main PCB.

6.14.4 Procedure

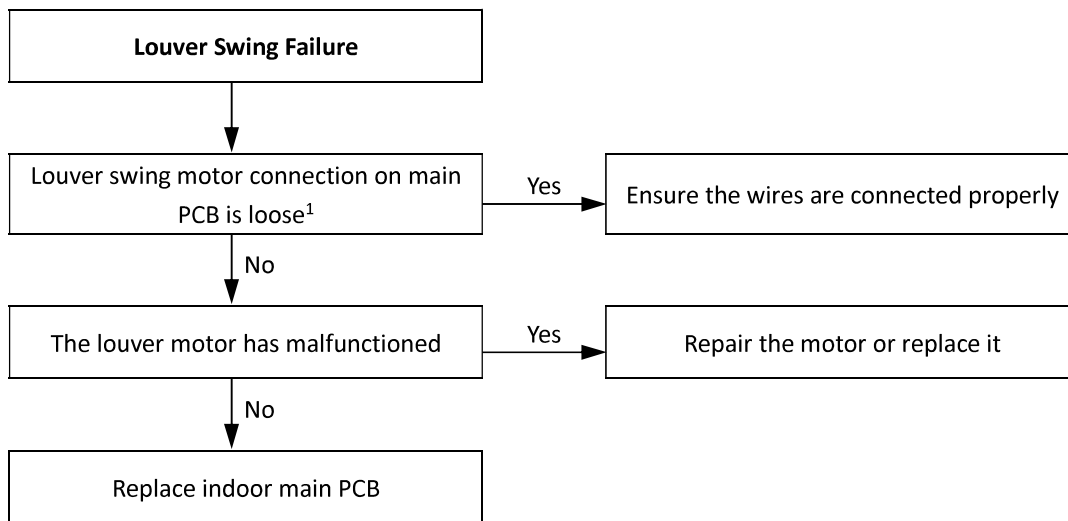

Notes:

1. The louver swing motor connection on each type of indoor unit main PCB is labeled in Figures 1.1 to 1.19 in 1, "Main PCB Ports".
2. Measure the resistance between the red wire and each of the other four wires (orange, yellow, pink and blue) at the louver swing motor connection on the main PCB. The resistances between the red wire and each of the other four wires should all be the same, should not be zero and should not be infinite. If the resistances are not the same, or if any of the resistances are zero or infinite, the louver swing motor has malfunctioned. The louver swing motor connection on each type of indoor unit main PCB is labeled in Figures 1.1 to 1.19 in 1, "Main PCB Ports". Refer also to Figure 5.2.

Figure 5.2: Louver swing motor connection wiring on indoor unit main PCBs

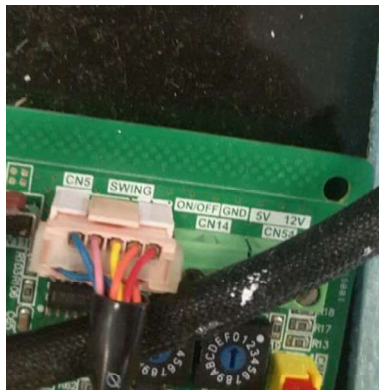

6.15 A1 Troubleshooting

6.15.1 Display output



6.15.2 Description

- Refrigerant leakage fault.

6.15.3 Impact on other units

- Refer to [5.2 “Impact on Other Units”](#).

6.15.4 Possible causes

- MS box actually detects that the quantity of connected refrigerant leakage sensors is not same as the quantity of sensors set by ENC1
- The refrigerant leakage sensor is open circuit, that is refrigerant leakage occurs
- MS box PCB malfunction

6.15.5 Procedure

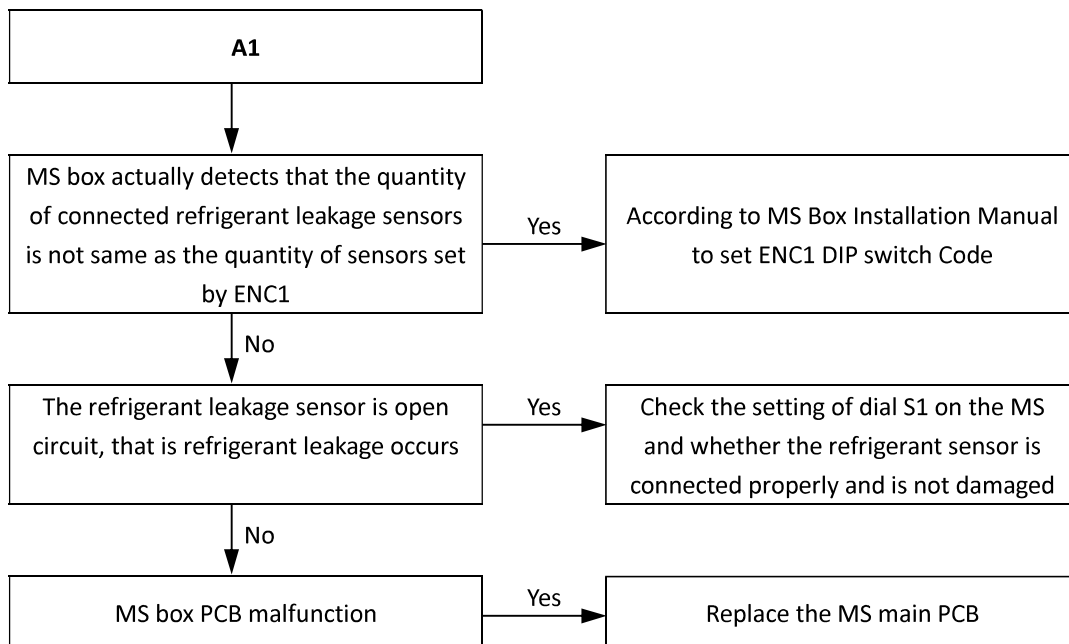

6.16 A0 Troubleshooting

6.16.1 Display output



6.16.2 Description

- The emergency stop.

6.16.3 Impact on other units

- Refer to [5.2 "Impact on Other Units"](#).

6.16.4 Possible causes

- MS box actually detects that the quantity of connected refrigerant leakage sensors is not same as the quantity of sensors set by ENC1
- The refrigerant leakage sensor is open circuit, that is refrigerant leakage occurs
- MS box PCB malfunction

6.16.5 Procedure

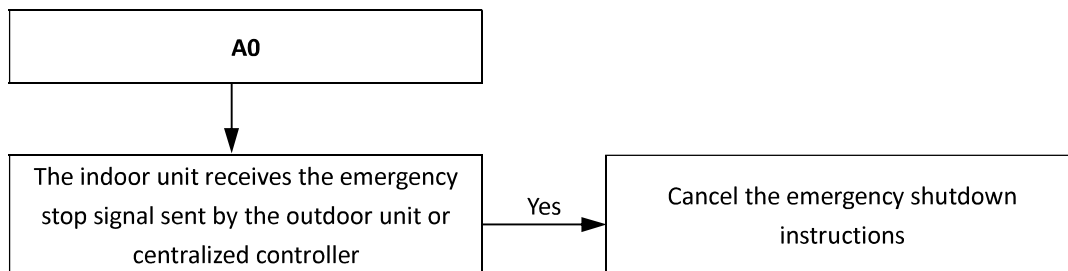

6.17 F7+repeated address (Alternating display with 1s as cycle) Troubleshooting

6.17.1 Display output



6.17.2 Description

- Repeated indoor units address.

6.17.3 Impact on other units

- Refer to [5.2 "Impact on Other Units"](#).

6.17.4 Possible causes

- Multiple virtual addresses will appear in high pressure duct 20-56kw. And it didn't restart after setting the unit capacity. The refrigerant leakage sensor is open circuit, that is refrigerant leakage occurs
- There are other indoor units that repeat the address.

6.17.5 Procedure

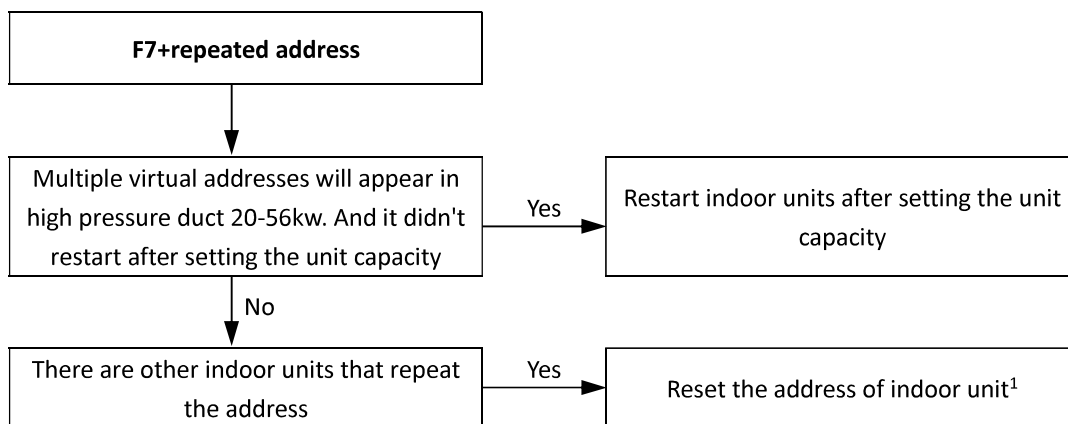

Notes:

1. The repeated address displayed on the display board cannot be used. The address range is 0-63#

6.18 U4 Troubleshooting

6.18.1 Display output



6.18.2 Description

- MS box self-check failure.

6.18.3 Impact on other units

- Refer to [5.2 "Impact on Other Units"](#).

6.18.4 Possible causes

- During the commissioning of the outdoor unit, the Outdoor find the indoor unit PQE connection and real refrigerant pipe connection is mismatch under the MS.

6.18.5 Procedure

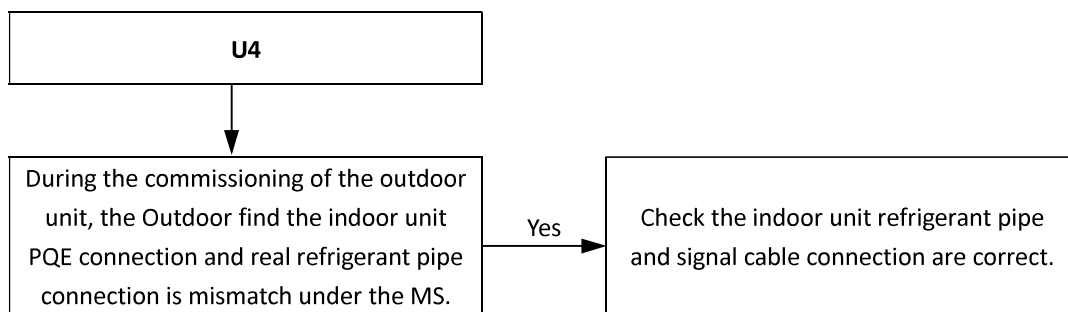

6.19 F8 Troubleshooting

6.19.1 Display output



6.19.2 Description

- MS box Error.

6.19.3 Impact on other units

- Refer to [5.2 "Impact on Other Units"](#).

6.19.4 Possible causes

- The connected MS box has error or protection.

6.19.5 Procedure

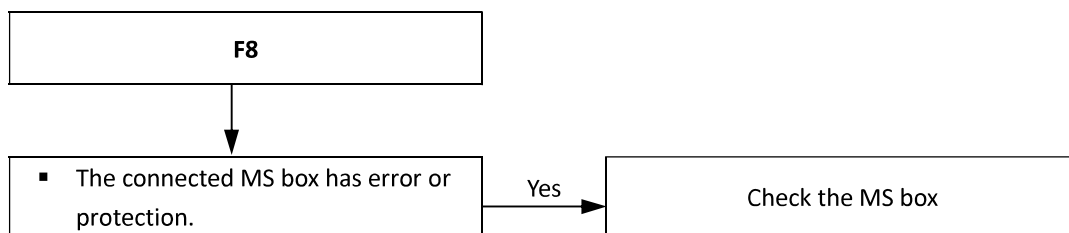

6.20 FA Troubleshooting

6.20.1 Display output



6.20.2 Description

- Capacity(HP) has not been set.

6.20.3 Impact on other units

- Refer to [5.2 "Impact on Other Units"](#).

6.20.4 Possible causes

- The indoor unit capacity has not been set by wired controller or remote controller.

6.20.5 Procedure

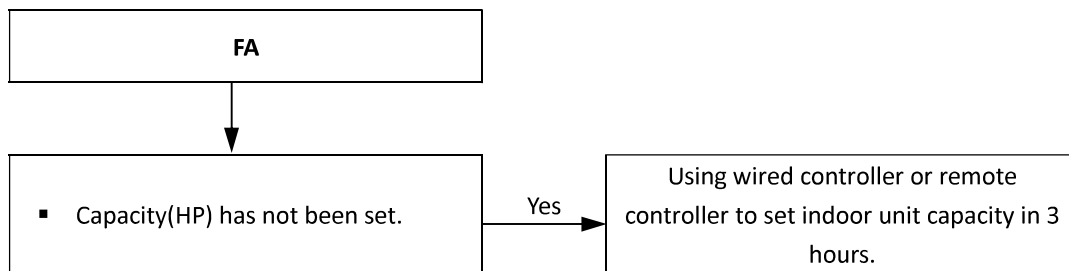

6.21 H4 Troubleshooting

6.21.1 Display output



6.21.2 Description

- Communication error between indoor unit and panel.

6.21.3 Impact on other units

- Refer to 5.2 “Impact on Other Units”.

6.21.4 Possible causes

- Communication wire between IDU main board and display board not connected properly.
- Panel is not compatible with the indoor unit.

6.21.5 Procedure

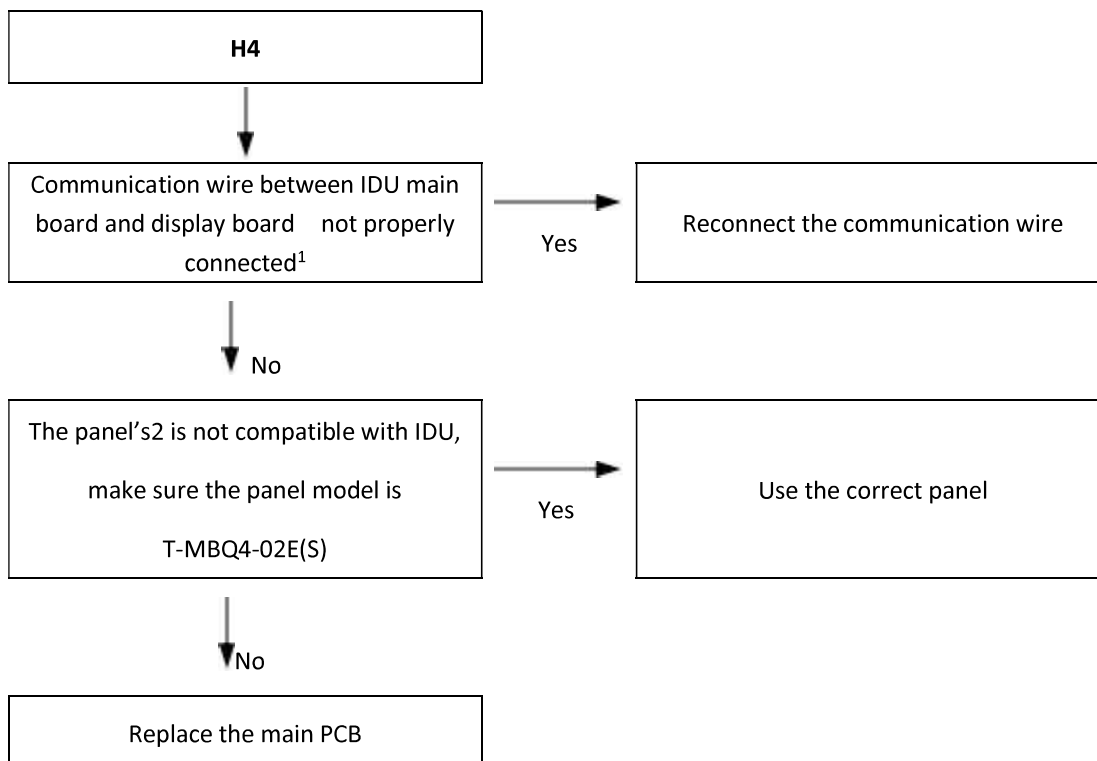

7 Appendix

7.1 Temperature Sensor Resistance Characteristics

Table 6.1: Indoor ambient temperature sensor, indoor heat exchanger mid-point temperature sensor and indoor heat exchanger outlet temperature sensor resistance characteristics

Temperature (°C)	Resistance (kΩ)	Temperature (°C)	Resistance (kΩ)	Temperature (°C)	Resistance (kΩ)	Temperature (°C)	Resistance (kΩ)
-20	115.3	20	12.64	60	2.358	100	0.6297
-19	108.1	21	12.06	61	2.272	101	0.6115
-18	101.5	22	11.50	62	2.191	102	0.5939
-17	96.34	23	10.97	63	2.112	103	0.5768
-16	89.59	24	10.47	64	2.037	104	0.5604
-15	84.22	25	10.00	65	1.965	105	0.5445
-14	79.31	26	9.551	66	1.896	106	0.5291
-13	74.54	27	9.124	67	1.830	107	0.5143
-12	70.17	28	8.720	68	1.766	108	0.4999
-11	66.09	29	8.336	69	1.705	109	0.4860
-10	62.28	30	7.971	70	1.647	110	0.4726
-9	58.71	31	7.624	71	1.591	111	0.4596
-8	56.37	32	7.295	72	1.537	112	0.4470
-7	52.24	33	6.981	73	1.485	113	0.4348
-6	49.32	34	6.684	74	1.435	114	0.4230
-5	46.57	35	6.400	75	1.387	115	0.4116
-4	44.00	36	6.131	76	1.341	116	0.4006
-3	41.59	37	5.874	77	1.291	117	0.3899
-2	39.82	38	5.630	78	1.254	118	0.3796
-1	37.20	39	5.397	79	1.2133	119	0.3695
0	35.20	40	5.175	80	1.174	120	0.3598
1	33.33	41	4.964	81	1.136	121	0.3504
2	31.56	42	4.763	82	1.100	122	0.3413
3	29.91	43	4.571	83	1.064	123	0.3325
4	28.35	44	4.387	84	1.031	124	0.3239
5	26.88	45	4.213	85	0.9982	125	0.3156
6	25.50	46	4.046	86	0.9668	126	0.3075
7	24.19	47	3.887	87	0.9366	127	0.2997
8	22.57	48	3.735	88	0.9075	128	0.2922
9	21.81	49	3.590	89	0.8795	129	0.2848
10	20.72	50	3.451	90	0.8525	130	0.2777
11	19.69	51	3.318	91	0.8264	131	0.2708
12	18.72	52	3.192	92	0.8013	132	0.2641
13	17.80	53	3.071	93	0.7771	133	0.2576
14	16.93	54	2.959	94	0.7537	134	0.2513
15	16.12	55	2.844	95	0.7312	135	0.2451
16	15.34	56	2.738	96	0.7094	136	0.2392
17	14.62	57	2.637	97	0.6884	137	0.2334
18	13.92	58	2.540	98	0.6682	138	0.2278
19	13.26	59	2.447	99	0.6486	139	0.2223



OMEGA
ENVIRONMENTAL
TECHNOLOGIES LLC.

17702 Mitchell North, #101
Irvine, CA. 92614 .USA
Tel: 714 795 2830
Fax: 714 966 1646
info@omegainverter.com
www.omegainverter.com

OTECTM
AIR CONDITIONING

Showroom & Technology Center
11380 Interchange Circle North
Miramar, FL 33025 .USA
Tel: 305 901 1270
Fax: 954 212 8280
info@otecomega.com
www.otecomega.com

BE_Series-SM1D1222